

H.265 5MP NVR SERIES

User Manual

Please read instructions thoroughly before operation and retain it for future reference.

Online manual download: www.surveillance-download.com/user/h517.swf

IMPORTANT SAFEGUARD



All lead-free products offered by the company comply with the requirements of the European law on the Restriction of Hazardous Substances (RoHS) directive, which means our manufacture processes and products are strictly “lead-free” and without the hazardous substances cited in the directive.



The crossed-out wheeled bin mark symbolizes that within the European Union the product must be collected separately at the product end-of-life. This applies to your product and any peripherals marked with this symbol. Do not dispose of these products as unsorted municipal waste. Contact your local dealer for procedures for recycling this equipment.



This is a class A product. In a domestic environment this product may cause radio interference in which case the user may be required to take adequate measures.

Federal Communications Commission Interference Statement

This equipment has been tested and found to comply with the limits for a Class A digital device, pursuant to Part 15 of the FCC Rules. These limits are designed to provide reasonable protection against harmful interference when the equipment is operated in a commercial environment. This equipment generates, uses, and can radiate radio frequency energy and, if not installed and used in accordance with the instruction manual, may cause harmful interference to radio communications. Operation of this equipment in a residential area is likely to cause harmful interference in which case the user will be required to correct the interference at his own expense.

This device complies with Part 15 of the FCC Rules. Operation is subject to the following two conditions:

- (1) This device must not cause harmful interference, and
- (2) This device must accept any interference received, including interference that may cause undesired operation.

Disclaimer

iPad and iPhone are trademarks of Apple Inc., registered in the U.S. and other countries. App Store is a service mark of Apple Inc.

IOS is a trademark or registered trademark of Cisco in the U.S. and other countries and is used under license.

Google Play and Android are trademarks of Google Inc

We reserve the right to revise or remove any content in this manual at any time. We do not warrant or assume any legal liability or responsibility for the accuracy, completeness, or usefulness of this manual. The content of this manual is subject to change without notice.

This product doesn't have a standby / off mode.

MPEG4 Licensing

THIS PRODUCT IS LICENSED UNDER THE MPEG4 VISUAL PATENT PORTFOLIO LICENSE FOR THE PERSONAL AND NON-COMMERCIAL USE OF A CONSUMER FOR (i) ENCODING VIDEO IN COMPLIANCE WITH THE MPEG4 VISUAL STANDARD ("MPEG-4 VIDEO") AND/OR (ii) DECODING MPEG4 VIDEO THAT WAS ENCODED BY A CONSUMER ENGAGED IN A PERSONAL AND NON-COMMERCIAL ACTIVITY AND/OR WAS OBTAINED FROM A VIDEO PROVIDER LICENSED BY MPEG LA TO PROVIDE MPEG4 VIDEO. NO LICENSE IS GRANTED OR SHALL BE IMPLIED FOR ANY OTHER USE. ADDITIONAL INFORMATION INCLUDING THAT RELATING TO PROMOTIONAL INTERNAL AND COMMERCIAL USES AND LICENSING MAY BE OBTAINED FROM MPEG LA, LLC. SEE [HTTP://WWW.MPEGLA.COM](http://www.mpegla.com).

GPL Licensing



This product contains codes which are developed by Third-Party-Companies and which are subject to the GNU General Public License ("GPL") or the GNU Lesser Public License ("LGPL").

The GPL Code used in this product is released without warranty and is subject to the copyright of the corresponding author.

Further source codes which are subject to the GPL-licenses are available upon request.

We are pleased to provide our modifications to the Linux Kernel, as well as a few new commands, and some tools to get you into the code. The codes are provided on the FTP site, and please download them from the following site or you can refer to your distributor:

<http://download.dvrtw.com.tw/GPL/NVR/T-Series/linux.tar.gz>

TABLE OF CONTENTS

1. HARDWARE OVERVIEW	1
1.1 Front Panel.....	1
1.2 Rear Panel	2
2. CONNECTION.....	3
2.1 Hard Disk Installation	3
2.2 Connection	6
2.3 Camera IP Configurations by LAN	7
3. FOR INITIAL USE	9
3.1 Setup Wizard.....	9
3.2 Mount Hard Disk.....	11
3.3 Change User Name and Password.....	11
4. USER INTERFACE	13
4.1 Local Access	13
4.2 Interface Overview	13
4.3 Status & Operation	14
4.3.1 Device Status	14
4.3.2 Channel Status.....	14
4.3.3 Main Menu.....	15
4.3.4 Playback Panel.....	17
5. FREQUENTLY-USED FUNCTIONS	18
5.1 IP Device Search.....	18
5.2 User Account Creation	19
5.3 System Logout	20
5.4 PTZ Control	20
5.5 Video Backup	22
6. MAIN MENU	23
6.1 CAMERA.....	23
6.1.1 CONNECTION	23
6.1.2 DEVICE.....	24
6.1.3 IMAGE.....	25
6.1.4 DETECTION.....	25
6.2 RECORD.....	27
6.3 SCENARIO.....	29
6.3.1 Pre-defined Scenarios.....	29
6.3.2 Scenario Customization	31
6.4 IVS.....	34
6.5 EXPORT.....	37
6.5.1 BACKUP.....	37
6.5.2 SCHEDULE.....	37
6.5.3 REGULAR REPORT	39
6.6 STORAGE	40
6.7 ACCOUNT	41
6.7.1 USER LIST	41
6.7.2 GROUP	42
6.8 NETWORK.....	43
6.8.1 E-MAIL	43

6.8.2 FTP.....	44
6.8.3 MULTICASTING.....	44
6.8.4 EaZy.....	45
6.9 TIME.....	45
6.10 DISPLAY.....	46
6.11 PERIPHERAL.....	47
6.11.1 LOCAL.....	48
6.11.2 JOYSTICK.....	49
6.12 MAINTAIN.....	49
6.12.1 SYSTEM.....	49
6.12.2 UPGRADE.....	50
6.12.3 ALERT.....	51
6.12.4 EVENT LOG.....	51
6.12.5 ONLINE.....	52
6.13 POWER CONTROL.....	52
6. REMOTE OPERATION.....	53
6.2 Web Browser.....	53
6.3 Mobile Devices.....	54
6.3.1 Prerequisites.....	54
6.3.2 Where to download.....	54
6.3.3 Setup.....	54
APPENDIX 1 PRODUCT SPECIFICATIONS.....	56
APPENDIX 2 PUSH VIDEO CONFIGURATION.....	58
A2.1 Alarm Sensor Connection.....	58
A2.2 Configuration.....	59
A2.2 Enable Push Video.....	59
A2.2.1 From iOS Mobile Device (iPhone / iPad).....	59
A2.2.2 From Android Mobile Device.....	60
APPENDIX 3 COMPATIBLE USB FLASH DRIVE LIST.....	61
APPENDIX 4 COMPATIBLE HARD DISK LIST.....	62
APPENDIX 5 BATTERY REPLACEMENT.....	63
APPENDIX 6 DISK ARRAY COMPATIBLE LIST.....	64
APPENDIX 7 EAZY NETWORKING.....	65
A8.1 Via EagleEyes on iOS / Android Device.....	65
A8.2 Via Internet Explorer on PC / Laptop.....	70
A8.3 Icons.....	75

1. HARDWARE OVERVIEW

1.1 Front Panel

Note: The functions on the front panel and rear panel may vary, depending on the mode you have.

1) Select & Unlock

These two buttons are used to unmount a hard disk. Press **Select** and check the HDD indicator (red & always on) to ensure the hard disk you want to unmount is chosen. Then, choose **Unlock** to unmount the hard disk (HDD indicator: red & flashing).

When the hard disk unmount is completed, the indicator will be off, and you're ready to remove the hard disk from the HDD tray.

2) HDD Indicators

Check the HDD indicator for each installed hard disk to ensure the hard disks work normally.







Note: Some statuses are for selected models only.

Color	Status	Meaning
--	No light	No hard disk is installed, or the installed hard disk is not detected. Please install a hard disk or replace the installed hard disk, and try again.
Green	Always on	The installed hard disk is detected well.
Green	Flashing	Data reading / writing.
Red	Always on	The hard disk is selected for unmounting.
Red	Flashing	The device is mounting or unmounting the selected hard disk.

3) Status LED indicators

Press to power on the device; press and hold for 3 seconds to power off the device.

Note: Some indicators are for selected models only.

	This device is power-supplied.
	The device is connected to Internet.
	The device is connected to LAN.
	An alarm event occurs.
err.	Any of the adapter, power or fan is abnormal.
	Video playback is on.
eSATA	An external disk array is connected.
	An USB flash drive or USB hard disk is connected.
	This device is in the standby mode when it's powered off.

4) Power (⏻)

Press to power on the device; press and hold for 3 seconds to power off the device.

5) Mouse port (Ⓜ)

Insert a mouse for function operation.

6) USB port (•⇄)

Insert a compatible USB flash drive for video backup.

Note: For the compatible list of USB flash drives, please refer to "APPENDIX 3 COMPATIBLE USB FLASH DRIVE LIST" at page 61.

1.2 Rear Panel

- 1) HDMI1
This port is used to connect the monitor which supports HDMI interface for main monitor output
- 2) HDMI2
This port is used to connect a secondary monitor which supports HDMI interface for secondary monitor output. For details, please refer to “6.10 DISPLAY” at page 46.
- 3) VGA
Connect to the VGA port of the monitor which supports VGA video output for main display output.
- 4) VIDEO OUT *(For selected models only)*
Connect to a CRT monitor for main monitor output.
- 5) eSATA *(For selected models only)*
This port is used to connect a storage device supporting eSATA interface; for instance, an external disk array.

Note: Please purchase a disk array supporting Linux system to ensure your device works properly. For the compatible list, please refer to “APPENDIX 6 DISK ARRAY COMPATIBLE LIST” at page 64.

Note: If the disk array is not connected or detected well, check the mode of your disk array, or do a reset default on your disk array and try again.

- 6) WAN
This port is used to connect your device to Internet.
- 7) LAN
This port is used to connect IP cameras to this device with a hub (if necessary) locally.
- 8) MIC IN
Connect to a microphone for audio transmission.
- 9) AUDIO OUT
Connect to a speaker for audio transmission.
- 10) External I/O Ports
These ports are used to connect external I/O devices, such as magnetic contacts or buzzers, or external control devices, such as other brand’s speed dome camera or keyboard controller.
- 11) USB 3.0
Insert a compatible USB flash drive or USB hard disk for video backup.

Note: For the compatible list of USB flash drives, please refer to “APPENDIX 3 COMPATIBLE USB FLASH DRIVE LIST” at page 61.

- 12) DC IN
Connect to the supplied adapter.
- 13)  Power Switch *(For selected models only)*
Switch to “—” to turn on the power, and “O” to turn off the power.

2. CONNECTION

2.1 Hard Disk Installation

Note: It's necessary to install a hard disk first before firmware upgrade to ensure the upgrade process works properly.

■ Type 1

Step1: Remove the top cover, and find the hard disk connector and bracket in the device.

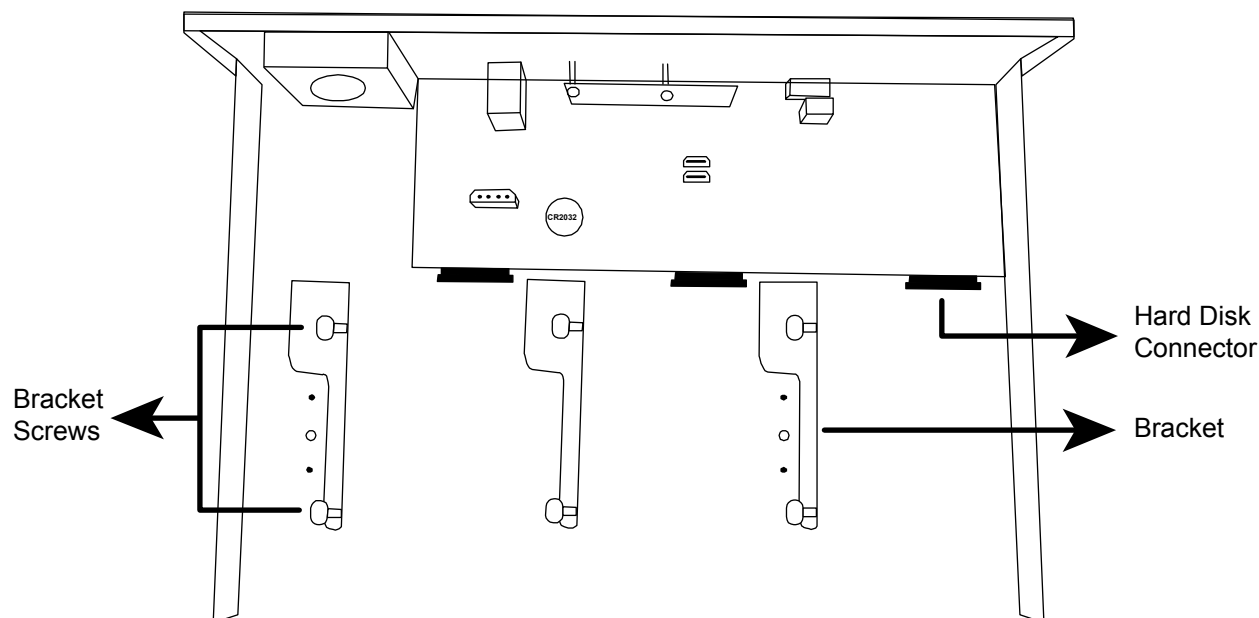

Step2: Get a compatible hard disk. With the PCB side facing down, insert the hard disk to one of the hard disk connector.

Note: To use a green hard disk, use **ONLY** the hard disk designed especially for surveillance to ensure the device works properly.

Step3: Fasten the hard disk to the bracket by securing the screws on the bracket.

Note: For the 16CH model which supports five hard disks, please go to "Additional Brackets for Two More Hard Disks" to know how to install the other two hard disks.

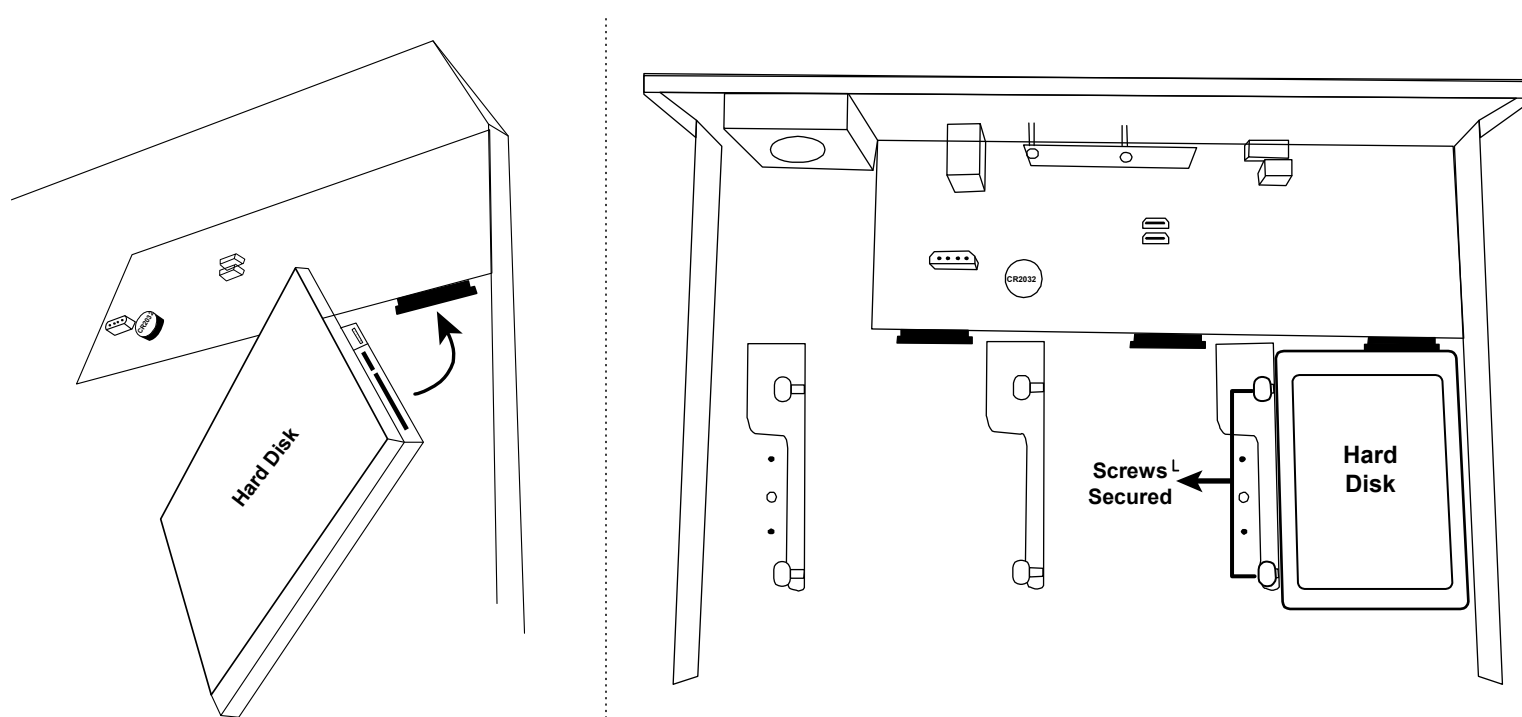

Step4: Replace the top cover and fasten the screws you loosened in Step1.

Additional Brackets for Two More Hard Disks

- Step1: For the 16CH model which supports five hard disks, find two pairs of HDD trays, SATA cables and power cables in the sales package.
- Step2: Find HDD brackets, power board connectors (white) and Sata board connectors (black) on the main board. To install a hard disk, three brackets, one power board connector (white) and one Sata board connector (black) are needed.

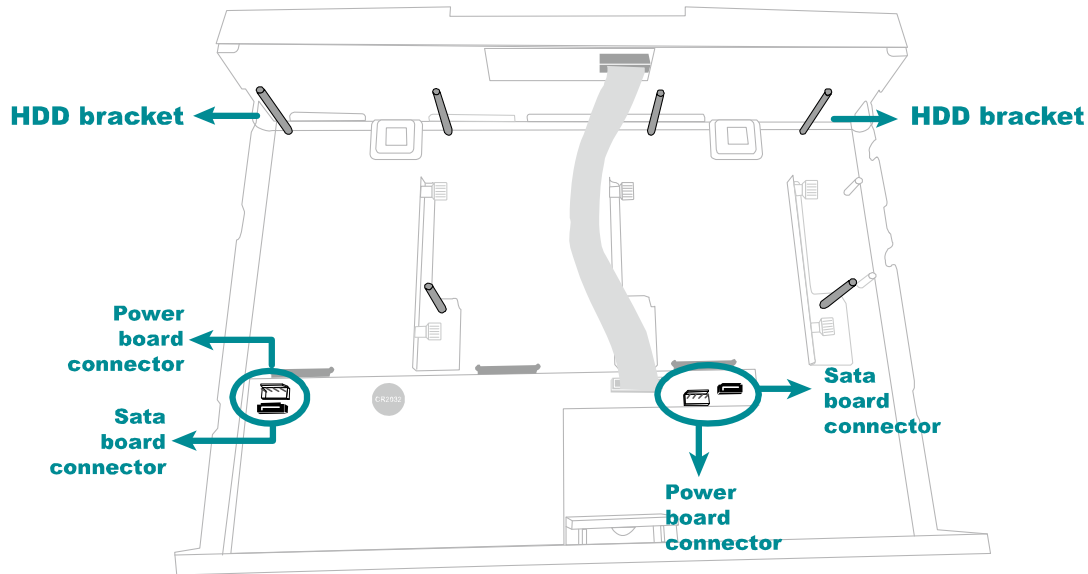

- Step3: Place the hard disk to the HDD tray and fix it on the tray with the supplied screws.

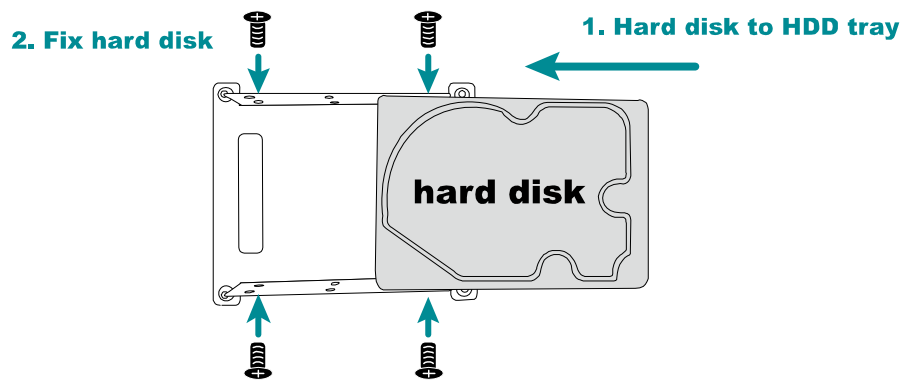

- Step4: Fix the HDD tray to the HDD brackets with the supplied screws.

- Step5: Connect the Sata cable and power cable to main board and the hard disk.

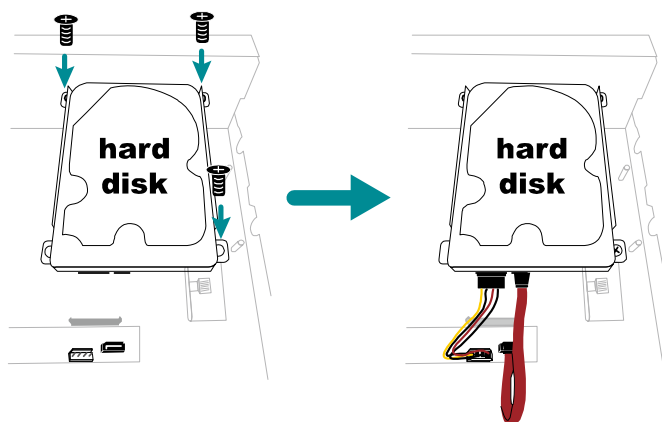

■ Type 2

Step1: Find the HDD tray and its accessories in the sales package, and place the rubber to the HDD tray as shown below.

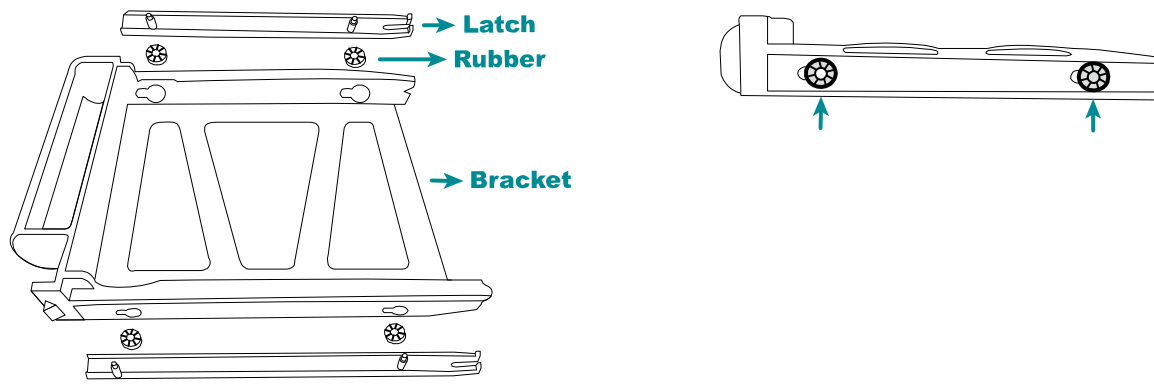

Step2: Get a compatible hard disk. With the PCB side facing down and the hard disk's connector facing the outside. Then, place the hard disk in the HDD tray and insert the latches.

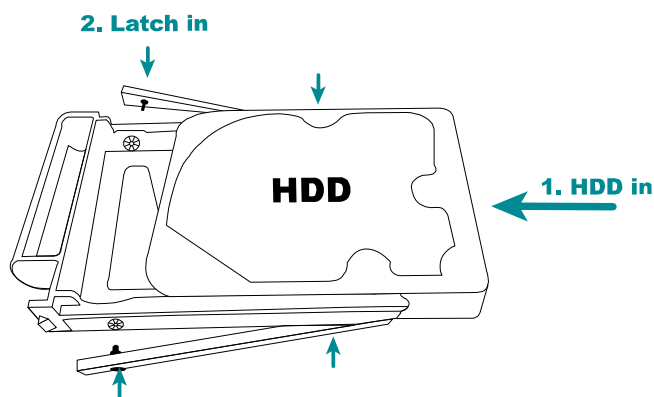

Step3: Remove the front cover by pulling from the left end of the cover as indicated below. You'll see eight HDD bays.

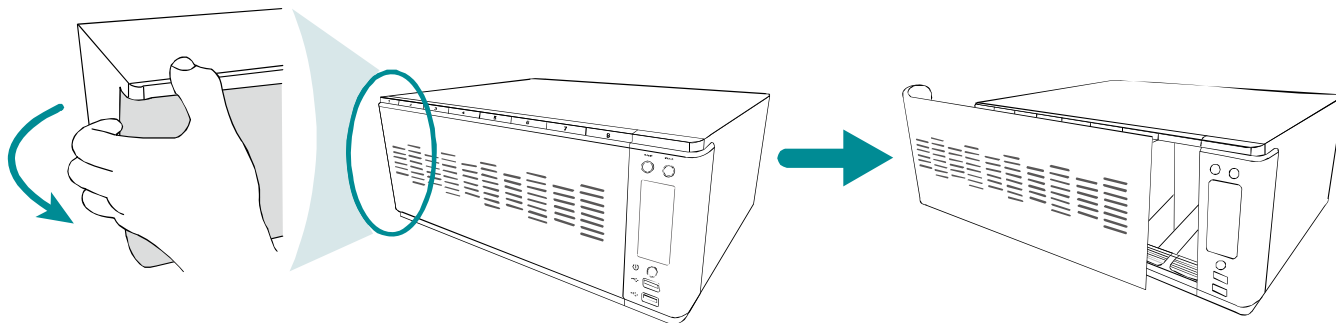

Step4: Push the HDD tray with a hard disk installed to the end of the HDD bay to ensure the hard disk is inserted properly.

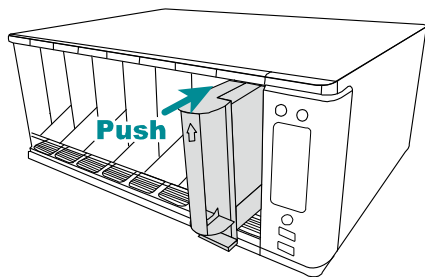

Step5: Replace the front cover removed in Step3 back to the NVR.

Step6: Power on the NVR and wait till the initialization is completed. Check if the HDD indicator on the front panel is flashing in red.

Note: Please check "HDD Indicators" in "1.1 Front Panel" for details.

Then, right click the mouse to exit from the full screen mode. Click **MENU** → **STORAGE** to see if all hard disks you inserted are detected, and click one by one to mount them. Wait till the hard disk is mounted and the status shows **READY**. When you're prompted to clear the hard disk, choose **YES**. For details, please check "6.6 STORAGE" at page 40.

2.2 Connection

Connect a monitor, IP cameras, adapters, a mouse, and other devices necessary to this recorder as illustrated below.

■ Type 1

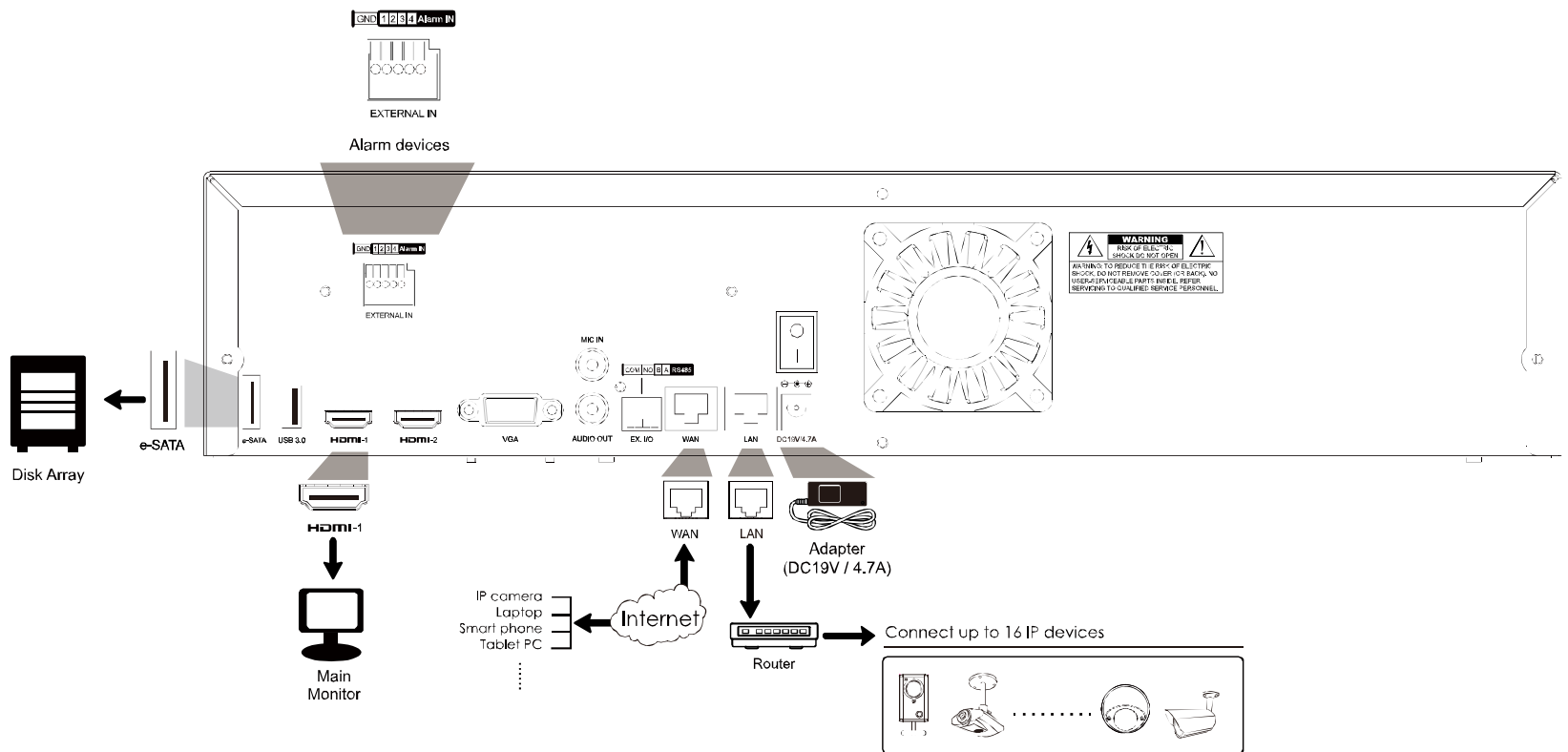

■ Type 2

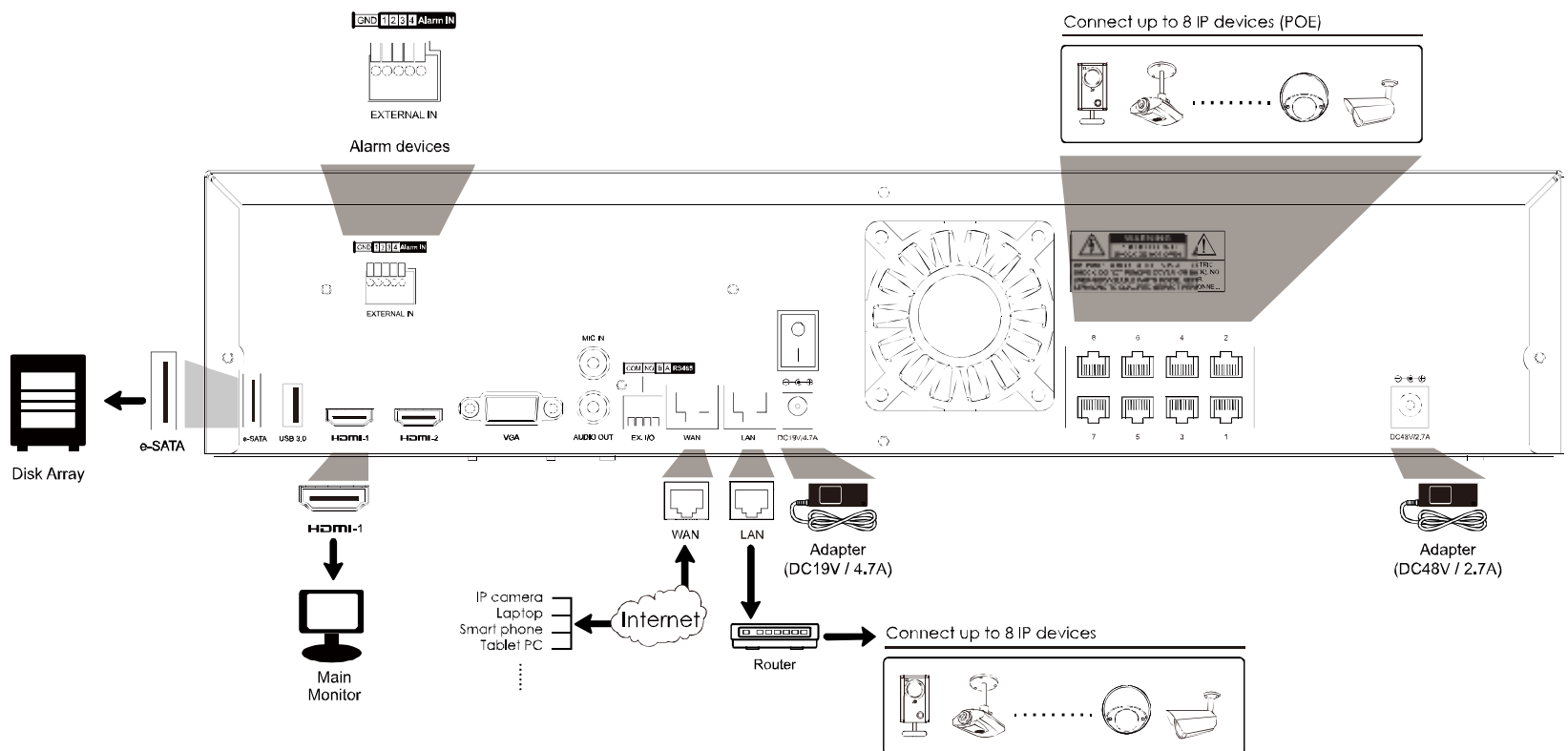

Then, power on the whole system and wait till the system initialization is done.

2.3 Camera IP Configurations by LAN

The auto mode is used to simplify the complicated network settings within three minutes. The connection mode of the LAN port is **AUTO** by default. This mode is suitable when the LAN port of the device is connected to a hub / switch.

Note: SETTING Path: **MENU** → **NETWORK** → **LAN** → **MODE**.

Note: For access this recorder remotely with your mobile device or laptop, you need to connect this recorder to Internet. For details, please get the setup manual from the supplied CD or from www.surveillance-download.com/user/network_setup/network_setup_recorder.pdf.

The device will automatically configure the IP address of a camera connected by LAN if:

- The connected IP camera is our brand's IP camera.
- The IP configuration method of the camera is **DHCP**.
- The camera is powered on before the device is powered on.

If the device **doesn't** configure the IP address of your camera automatically as described above, your IP camera might **NOT** be:

- Our brand's IP camera.
- Set to **DHCP** as its default IP configuration method.

To solve this, reconfigure the IP address of the camera to 10.1.1.xx (xx ranges from 11 ~ 253), which is in the same network segment as the device.

- For other brand's IP camera, please check its user manual to know how to change the IP address manually.
- For our brand's IP camera, please check the instructions below:
 - a) Go to **MENU** → **CAMERA** → **CONNECTION**, and select **IP SEARCH** at the bottom right corner. You'll see the list of every connected IP camera with its connection status to this device and MAC address.

IP SEARCH									
ASSIGN	EDIT	DEVICE TYPE	IP	NETMASK	GATEWAY	PRIMARY DNS	PORT	MAC	VENDOR
<input type="checkbox"/>		IPCAM	10.2.1.33	255.255.255.0	10.2.1.10	8.8.8.8	88	00:0E:53:31:06:E5	AVTECH
							REFRESH	ADD	

The device will **automatically** configure the IP address of a camera connected by LAN if:

- The connected IP camera is our brand's IP camera.
- Reset the IP camera to default value (the default IP configuration method of the camera is "DHCP").
- The camera is powered on before the device is powered on.

If the device **doesn't** configure the IP address of your camera automatically as described above, your IP camera might **NOT** be:

- Our brand's IP camera.
- Set to "DHCP" as its default IP configuration method.

- b) To solve this, use our brand's IP camera, and reconfigure its IP address to 10.1.1.xx (xx ranges from 11 ~ 253). Select  (EDIT), and change the network type from **STATIC** to **DHCP**. Then, Click **APPLY** to save your changes.

SETUP	
NETWORK TYPE	DHCP
IP	10.1.1.14
PORT	88
USER NAME	Admin
PASSWORD	*****
NETMASK	255.255.255.0
GATEWAY	10.1.1.10
PRIMARY DNS	8.8.8.8
<input type="button" value="CANCEL"/> <input type="button" value="APPLY"/>	

- c) Check to assign the camera to a specific channel automatically, and choose **ADD**.

IP SEARCH											
ASSIGN	EDIT	DEVICE TYPE	IP	NETMASK	GATEWAY	PRIMARY DNS	PORT	MAC	VENDOR		
<input checked="" type="checkbox"/>		IPCAM	10.1.1.14	255.255.255.0	10.1.1.10	8.8.8.8	88	00:0E:53:31:06:E5	AVTECH		
							<input type="button" value="REFRESH"/>	<input type="button" value="ADD"/>			

- d) The device will then detect the IP camera and display images soon.

Note: To configure this recorder to access other IP camera connected remotely for live viewing or video backup, you need to connect this recorder to Internet first.

3. FOR INITIAL USE

For the first time to power on this device, you might be prompted to:

- Go through the setup wizard
- Clear hard disk
- Change default user name and password

3.1 Setup Wizard

The setup wizard is prompted to guide you finishing the most common settings you might need to do.

Note: It's okay to skip the wizard. You can configure the following settings later in their respective menus.

SETUP WIZARD	
	ENGLISH ▼
<p>WELCOME TO THE SETUP WIZARD. PLEASE FOLLOW THE WIZARD TO FINISH BASIC CONFIGURATIONS.</p>	
<input type="button" value="SKIP"/>	<input type="button" value="NEXT"/>

Select **NEXT** to go to the next step.

SETUP WIZARD	
<p>PLEASE INPUT THIS MACHINE NAME</p> <div style="border: 1px solid black; width: 150px; height: 20px; margin: 0 auto;"></div>	
<input type="button" value="SKIP"/>	<input type="button" value="PREV"/> <input type="button" value="NEXT"/>

Name the device. If you don't want to name the device, just skip to the next step.

Note: To name the device later, please go to **MAINTAIN** → **SYSTEM**.

SETUP WIZARD	
USER NAME	office_hd
PASSWORD	office145
CONFIRM PASSWORD	office145
<p>PLEASE INPUT THE ADMINISTRATOR'S USER NAME AND PASSWORD.</p>	
<input type="button" value="SKIP"/>	<input type="button" value="PREV"/> <input type="button" value="NEXT"/>

Change the default user name and password. If you don't change the user name and password here, you're not able to go to the next step. This step is compulsory.

Note: To change or edit user name and passwords, please go to **SYSTEM** → **ACCOUNT** → **USER LIST**.

SETUP WIZARD	
DATE	2015/MAR/05
TIME	14:33:46
FORMAT	Y/M/D ▼
GMT	GMT+08:00 ▼
<div style="display: flex; justify-content: space-between;"> SKIP PREV NEXT </div>	

Set the date and time.

If you don't want to set the date and time now, just skip to the next step. However, it's necessary to keep the date and time right to ensure the accuracy of the recorded data.

Note: To set the date and time later, please go to **MENU** → **TIME**.

SETUP WIZARD	
NTP SERVER	Pool.ntp.org
SYNC PERIOD	OFF ▼
<div style="display: flex; justify-content: space-between;"> SKIP PREV NEXT </div>	

Configure if you want to connect this device to an NTP server to get the right time online.

Note: To set the date and time later, please go to **MENU** → **TIME**.

SETUP WIZARD	
NETWORK TYPE	STATIC ▼
IP	192.168.1.10
GATEWAY	192.168.1.1
NETMASK	255.255.255.0
PRIMARY DNS	8.8.8.8
SECONDARY DNS	168.95.1.1
PORT	80
<div style="display: flex; justify-content: space-between;"> SKIP PREV NEXT </div>	

Configure network setup by using the traditional method. For details, please download the instructions from www.surveillance-download.com/user/network_setup/network_setup_recorder.pdf.

Note: To configure network setup by using the traditional method later, please go to **MENU** → **NETWORK**.

SETUP WIZARD	
SMTP SERVER	Smtplib@gmail.com
PORT	465
MAIL FROM	manager@gmail.com
SSL ENCRYPTION	ON
VERIFY PASSWORD	ON
USER NAME	manager@gmail.com
PASSWORD	●●●●●●
<div style="display: flex; justify-content: space-between;"> SKIP PREV NEXT </div>	

Configure event notifications by email.

Note: To configure email notifications later, please go to **MENU** → **NETWORK** -> **E-MAIL**.

SETUP WIZARD	
DDNS	ON
SYSTEM NAME	Eagleeyes ▼
HOST NAME	MAC000E533A3D
E-MAIL	
CURRENT HOST ADDRESS	MAC000E533A3D4A.ddns.eagleeyes.tw
SKIP	PREV NEXT

Enable DDNS if needed.





Note: To enable the DDNS later, please go to **MENU** → **NETWORK** → **DDNS**.

3.2 Mount Hard Disk

When this device is powered on, you'll see the hard disk indicators are flashing in red, indicating the hard disk are not detected by this recorder.

Right click the mouse to exit from the full screen mode. Click **MENU** → **STORAGE** to see the status of each connected hard disks. Click one by one to mount them. When you're prompted to clear the hard disk, choose **YES**.

When the hard disk is mounted, the status will be changed from **MOUNTING** to **READY**.

STORAGE									
HDD NEARLY FULL (GB)							5	▼	
HDD OVERHEAT ALERT (°C)							70	▼	
OVERWRITE							ON		
KEEP DATA LIMIT(DAYS)							OFF	▼	
TEMPERATURE TO ENABLE FAN							30	▼	
	ID	TYPE	STATUS	SIZE	TEMP.	SERIAL NUMBER	FREE SIZE	FORMAT TIME	HEALTH STATUS
  <input checked="" type="checkbox"/>	HDD 5-1	NORMAL	INACTIVE	750GB	--	WD-WCAV53797317	269.856GB	2017/07/18 23:03:52	GOOD
  <input checked="" type="checkbox"/>	HDD 5-2	NORMAL	INACTIVE	1.00TB	--	WD-WMC1U5344933	9.88GB	2017/07/18 23:10:55	GOOD

3.3 Change User Name and Password



It's highly recommended to change the user name and password of this device to keep your account safe. Otherwise, any person could access this device if he knows the default user name and password.

If you didn't go through the setting wizard at the first place, you'll be prompted to change the user name and password:

WARNING
PLEASE BE ADVISED TO MODIFY THE DEFAULT ACCOUNT TO ENSURE YOUR INFORMATION SECURITY.
<input checked="" type="radio"/> MODIFY <input type="radio"/> REMIND ME LATER <input type="radio"/> DON'T REMIND ME ANYMORE
CONFIRM

Choose **MODIFY** to start the change immediately.

To change later, go to **MENU** → **ACCOUNT** → **USER LIST**, and choose  to change the default user name and password of **SUPERVISOR**.

USER LIST		USER LIST	
GROUP	EDIT	USER NAME	GROUP
	 	admin	SUPERVISOR
			

4. USER INTERFACE

4.1 Local Access

Connect your USB mouse to one of the USB ports on the front panel, and move your mouse to enter the password with the password keypad. The default user name and password are both **admin**.

When you log into the system, the display is in the full screen mode. Right click the mouse to show the tool bar and function panel.

Note: You may also customize a user level to have different access privileges in **ACCOUNT** → **GROUP**. For details, please refer to "6.7.2 GROUP" at page 42.

Password Input

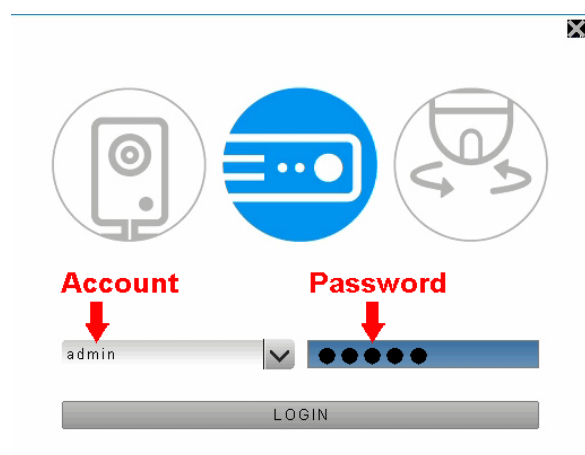



















4.2 Interface Overview







4.3 Status & Operation

4.3.1 Device Status

Note: The functions shown may vary based on the model or the access user level you use.















	Key lock		Key unlock
	Channel lock		Channel unlock
	USB flash drive / device connected		No USB device connected
	Timer record on		Timer record off
	Overwrite on		Overwrite off
	Sequence mode on		Sequence mode off
	PTZ mode on		PTZ mode off
	USB backup in progress		USB flash drive full
	USB backup failed		CPU loading

Network Status:

	(WAN) Internet connected		(WAN) Internet disconnected
	(WAN) Local connection		
	(LAN) DHCP / Static IP mode		(LAN) Camera disconnected







4.3.2 Channel Status



Note: The functions shown may vary based on the model or the access user level you use.

	Camera disconnected		Original size		Fit to screen		Digital zoom
	Audio on		Audio off		Alarm out		Alarm out disabled
	Recording		Alarm event		Motion event		PIR event
	Add a camera by auto search		Add a camera manually		IP camera setup		

4.3.3 Main Menu

Click **MENU** on the bottom left corner to show the main menu list and its sub items:

	CAMERA	CONNECTION	IP SEARCH
		DEVICE	
		IMAGE	BRIGHTNESS
			CONTRAST
			SATURATION
DETECTION			
	RECORD	LIVE STREAM	
		RECORD STREAM	
		SUBSTREAM	
	SCENARIO		
	IVS		
	EXPORT	BACKUP	
		SCHEDULE	
		REGULAR REPORT	
	STORAGE		HDD NEARLY FULL (GB)
			HDD OVERHEAT ALERT(°C)
			OVER WRITE
			KEEP DATA LIMIT(DAYS)
			TEMPERATURE TO ENABLE FAN
	ACCOUNT	USER LIST	
		GROUP	
	NETWORK	WAN	
		LAN	
		DDNS	
		E-MAIL	
		FTP	
		MULTICASTING	
		EaZy	
	TIME	TIME SETUP	DATE
			TIME
			FORMAT
			NTP SERVER
			SYNC PERIOD
			GMT
			CLIENT TIME SYNC VIA NVR WAN
	DISPLAY		CHANNEL TITLE
			EVENT STATUS
			HDD DISPLAY MODE
			DISPLAY OUTPUT
			LANGUAGE
			HDMI2 DISPLAY
			COMPOSITE OUTPUT

	PERIPHERAL	LOCAL	MOUSE SENSITIVITY
			REMOTE CONTROL ID
		JOYSTICK	
	MAINTAIN	SYSTEM	BACKUP CONFIG RESTORE CONFIG RESET DEFAULT DEVICE TITLE ENABLE EASY MAINTENANCE ENABLE AUTO PLUG AND PLAY BIND MAC ADDRESS
		UPGRADE	LOCAL CAMERA
		ALERT	EXT. ALERT INT. ALERT KEY BUZZER VLOSS BUZZER MOTION BUZZER ALARM BUZZER HDD BUZZER ALARM DURATION (SEC)
		EVENT LOG	
		ONLINE	ANONYMOUS VIEWER LOGIN DROP ALL CONNECTION LOGIN FAILURE TIMES LOCK TIME FOR LOGIN FAILURES
	POWER CONTROL	HALT THE SYSTEM	
		REBOOT THE SYSTEM	
		LOGOUT	





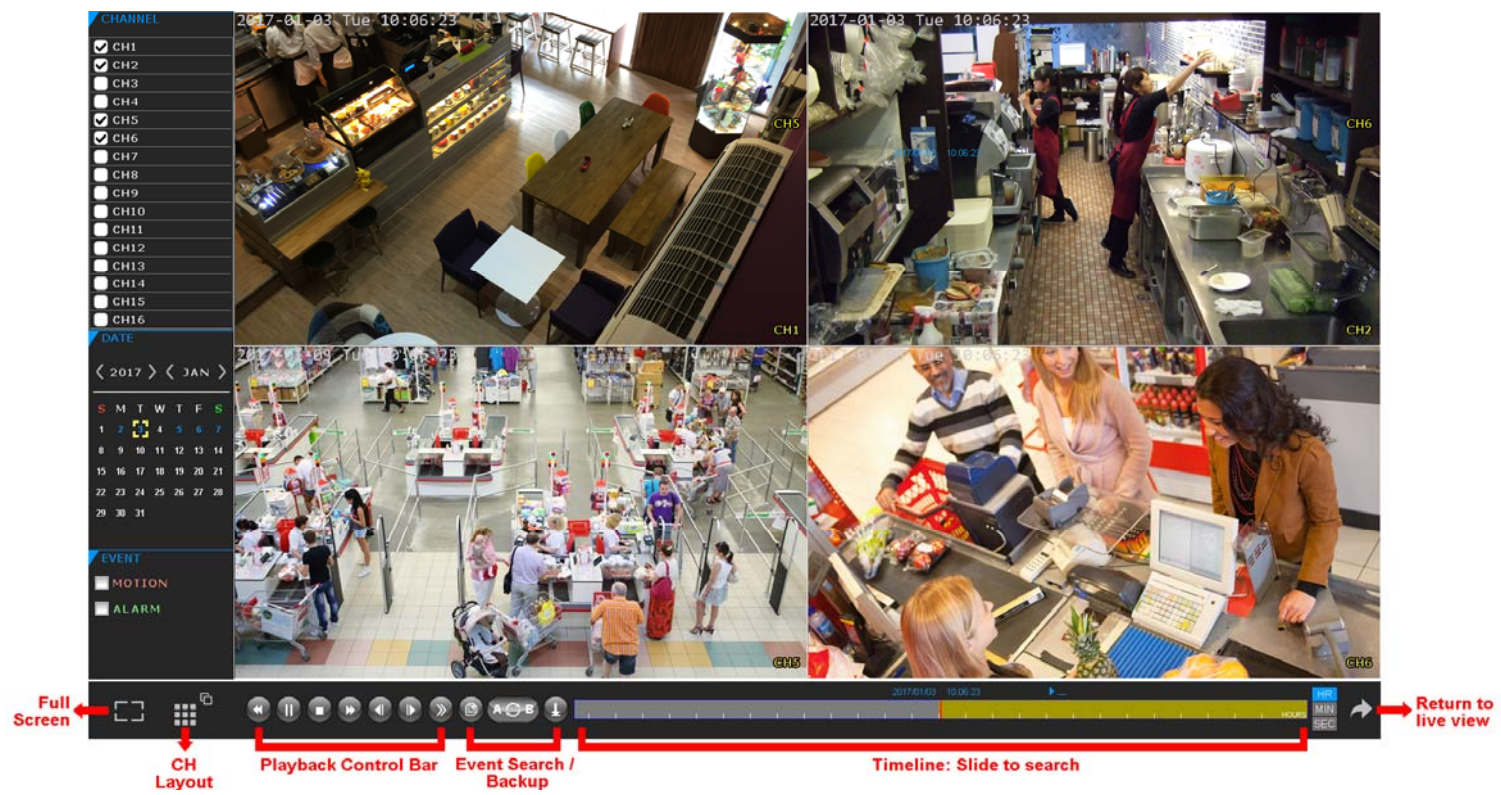





4.3.4 Playback Panel

Click  to go to the playback panel.



- Step1: In **CHANNEL**, choose the channel(s) you want to search.
- Step2: In **DATE**, the date(s) which includes video footage of the selected channel(s) will be marked in blue. Choose the date you want.
- Step3: (Optional) In **EVENT**, choose the event type(s) to narrow down the search if needed.
- Step4: Slide the timeline to search the time segment within which includes video footage. The time segment within which includes video footage is marked in yellow-green.
- Step5: Move to the time segment you want and video playback starts automatically.

Playback Control

	Fast Forward	Increase the speed for fast forward.
	Fast Rewind	Increase the speed for fast rewind.
	Play / Pause	Click to play the latest recorded video clip immediately, and click again to pause. In the pause mode, click  once to get one frame forward, and click  to get one frame rewind.
	Stop	Click to stop the video playback.
	Slow Playback	Click once to get 1/4X speed playback, and click twice to get 1/8X speed playback.
	Previous / Next Hour	Click to jump to the next / previous time interval in an hour, for example, 11:00 ~ 12:00 or 14:00 ~ 15:00, and start playing the earliest event video clip recorded during this whole hour.
	Event List	Click to enter the quick search menu for specific record data search, or select FULL to show all event logs.
	Repeat	Click to set point A and point B in a video clip, and the system will play only the specified range in that clip.
	Backup	Click to open the backup menu for video backup.

5. FREQUENTLY-USED FUNCTIONS

5.1 IP Device Search

Note: This function is applicable only for our brand’s IP camera. For other brand’s IP camera, please check its user manual to know how to change the IP address manually under the network segment of 10.1.1.xx (xx ranges from 11 ~ 253).

Go to **MENU → CAMERA → CONNECTION**, and select **IP SEARCH** at the bottom right corner. You’ll see the list of every connected IP camera with its connection status to this device and MAC address.

IP SEARCH									
ASSIGN	EDIT	DEVICE TYPE	IP	NETMASK	GATEWAY	PRIMARY DNS	PORT	MAC	VENDOR
<input type="checkbox"/>		IPCAM	10.2.1.33	255.255.255.0	10.2.1.10	8.8.8.8	88	00:0E:53:31:06:E5	AVTECH
							REFRESH	ADD	

Make sure the IP address of the connected camera is under the network segment of 10.1.1.xx (xx ranges from 11 ~ 253). If not, select and change the network type from **STATIC** to **DHCP**. Then, Click **APPLY** to save your changes.



SETUP	
NETWORK TYPE	DHCP
IP	10.1.1.14
PORT	88
USER NAME	Admin
PASSWORD	*****
NETMASK	255.255.255.0
GATEWAY	10.1.1.10
PRIMARY DNS	8.8.8.8
<input type="button" value="CANCEL"/> <input type="button" value="APPLY"/>	

Check to assign the camera to a specific channel automatically, and choose **ADD**.

IP SEARCH									
ASSIGN	EDIT	DEVICE TYPE	IP	NETMASK	GATEWAY	PRIMARY DNS	PORT	MAC	VENDOR
<input checked="" type="checkbox"/>		IPCAM	10.1.1.14	255.255.255.0	10.1.1.10	8.8.8.8	88	00:0E:53:31:06:E5	AVTECH
							REFRESH	ADD	

5.2 User Account Creation

To create different user account for different access privilege, go to **MENU → ACCOUNT → USER LIST**, and choose  to create a new account.

USER LIST		USER LIST		
GROUP	EDIT	USER NAME	GROUP	
	 	admin	SUPERVISOR	
				

Four user levels are pre-defined in the system for you to quickly choose: SUPERVISOR, POWER USER, USER & GUEST.

Note: You can also customize a user level based on your needs by going to **MENU → ACCOUNT → GROUP**. For details, please go to "6.7.2 GROUP" at page 42.

Function	User Level			
	SUPERVISOR	POWER USER	USER	GUEST
■ GENERAL				
BACKUP	✓	✓		
PTZ CONTROL	✓	✓		
POWER CONTROL	✓			
REVIEW LOG	✓			
CONFIG SETUP	✓			
CLEAR LOG	✓			
ACCOUNT SETUP	✓			
CLEAR HDD	✓			
PUSH VIDEO	✓			
PUSH STATUS	✓			
ALARM OUT	✓	✓		
■ LOCAL				
LIVE VIDEO	✓	✓	✓	✓
LIVE AUDIO	✓	✓	✓	
PLAYBACK VIDEO	✓	✓		
PLAYBACK AUDIO	✓	✓		
■ NETWORK				
LIVE VIDEO	✓		✓	✓
LIVE AUDIO	✓		✓	
PLAYBACK VIDEO	✓			
PLAYBACK AUDIO	✓			

5.3 System Logout

When different user accounts are created for system management, make sure you log out after your access in case other people access the system with your account.

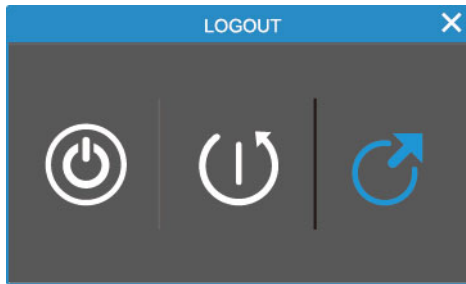

Choose **MENU** → **POWER CONTROL**, and choose  to log out the system.









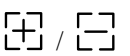



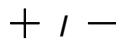







Note: The default user name and password are both **admin**, which is the highest user level.

5.4 PTZ Control





	Enter	Click to confirm your selection / enter the menu.
	Up / Down / Left / Right	Click the arrow keys (▲ / ▼ / ◀ / ▶) to more the camera lens up / down / left /right.
Camera Control		
	Iris + / Iris -	This two buttons are designed for the PTZ camera which uses Pelco-D to control. To know the actions after clicking Iris + and Iris -, please refer to the camera's user manual.
	Focus near / far	Click to adjust the focus of the image.

 Camera Control		
	Zoom in / out	Click to zoom in / out on the image. Users could also zoom in / out on the image by simply drawing a square on the screen, and the zoom ratio depends on how large the square is. <ul style="list-style-type: none"> ■ Zoom in: Draw the square from top left to bottom right. ■ Zoom out: Draw the square from bottom right to left top.
	Zoom in / out max	Click to zoom in on the image to the largest / zoom out on the image to its original size.
	Auto mode	Click to activate the auto function. Before using it, you need to assign a specific function that will be enabled when  is clicked. For details, please refer to the user manual of the camera.
	Auto tracking	Click to start auto tracking when your speed dome camera supports this function.
	Hot point	Click on the screen to move and center the camera view to the point you just clicked.
	Config.	Click to configure the speed to pan / tilt the speed dome camera.
	Joystick	Click to control the movement of a speed dome camera or a motorized-pan camera. Drag and hold the mouse on the screen to move the camera. You'll see ● and ● with arrow on the screen. The farther these two icons, the faster the movement.
 Preset Point		
01 ~ 10	Preset point 01 ~ 10	These ten buttons are used for preset point 1 ~ 10. To set or go to other preset point (such as 15), please enter the numbering manually in the input box next to  , and choose  to set the preset point, or  to go to the preset point.
	Set preset point	Move the camera view to the point you want to set, and click the numbering you want from 01 ~ 10, or enter the numbering manually in the input box next to  . Then, click  to confirm.
	Go to preset point	To go to the preset point from 1 ~ 10, simply click the button. To go to the other preset point out of 10, enter the numbering manually in the input box next to  , and choose  to confirm.

5.5 Video Backup

Note: Before using the USB flash drive, please use your PC to format the USB flash drive to FAT32 format first. For the list of compatible USB flash drives, please refer to "APPENDIX 3 COMPATIBLE USB FLASH DRIVE LIST at page 61.

Note: For video backup, please use USB flash drive or back your data up over the Internet. It's **NOT** allowed to connect the hard disk to your PC and get the video data directly.

To copy recorded data for video backup, click  to go to the playback panel, and choose  at the bottom tool bar to open the backup menu:

BACKUP

<p>SOURCE</p> <p>DATA TYPE <input checked="" type="checkbox"/> VIDEO <input type="checkbox"/> LOG</p> <p>RANGE 2017/07/18 23:03:52 ~ 2017/07/18 23:03:52</p> <table border="1" style="width: 100%; border-collapse: collapse; text-align: center;"> <tr> <td style="width: 15%;">< 2017 ></td> <td style="width: 12.5%; color: red;">SUN</td> <td style="width: 12.5%;">MON</td> <td style="width: 12.5%;">TUE</td> <td style="width: 12.5%;">WED</td> <td style="width: 12.5%;">THU</td> <td style="width: 12.5%;">FRI</td> <td style="width: 12.5%; color: green;">SAT</td> </tr> <tr> <td></td> <td>1</td> <td>2</td> <td>3</td> <td>4</td> <td>5</td> <td>6</td> <td>7</td> </tr> <tr> <td></td> <td>8</td> <td>9</td> <td>10</td> <td>11</td> <td>12</td> <td>13</td> <td>14</td> </tr> <tr> <td></td> <td>15</td> <td>16</td> <td style="border: 2px solid yellow;">17</td> <td style="border: 2px solid yellow;">18</td> <td style="border: 2px solid yellow;">19</td> <td style="border: 2px solid yellow;">20</td> <td style="border: 2px solid yellow;">21</td> </tr> <tr> <td style="color: red;">< JUL ></td> <td>22</td> <td>23</td> <td>24</td> <td>25</td> <td>26</td> <td>27</td> <td>28</td> </tr> <tr> <td></td> <td>29</td> <td>30</td> <td>31</td> <td></td> <td></td> <td></td> <td></td> </tr> </table> <p style="text-align: center; font-size: small;">< 23:03:52 > HR MIN SEC</p> <p style="text-align: right; font-size: x-small;">HOURS</p>	< 2017 >	SUN	MON	TUE	WED	THU	FRI	SAT		1	2	3	4	5	6	7		8	9	10	11	12	13	14		15	16	17	18	19	20	21	< JUL >	22	23	24	25	26	27	28		29	30	31					<p>DESTINATION</p> <p>TARGET USB DEVICE <input checked="" type="checkbox"/></p> <p>AVAILABLE SIZE 3 GB</p> <p>STORAGE</p> <p>USB PATH <input type="text" value="/VIDEO"/> ...</p>
< 2017 >	SUN	MON	TUE	WED	THU	FRI	SAT																																										
	1	2	3	4	5	6	7																																										
	8	9	10	11	12	13	14																																										
	15	16	17	18	19	20	21																																										
< JUL >	22	23	24	25	26	27	28																																										
	29	30	31																																														
<p>CHANNEL <input type="checkbox"/> ALL</p> <table border="1" style="width: 100%; border-collapse: collapse; text-align: center;"> <tr> <td>CH1</td><td>CH2</td><td>CH3</td><td>CH4</td> </tr> <tr> <td>CH5</td><td>CH6</td><td>CH7</td><td>CH8</td> </tr> <tr> <td>CH9</td><td>CH10</td><td>CH11</td><td>CH12</td> </tr> <tr> <td>CH13</td><td>CH14</td><td>CH15</td><td>CH16</td> </tr> </table>		CH1	CH2	CH3	CH4	CH5	CH6	CH7	CH8	CH9	CH10	CH11	CH12	CH13	CH14	CH15	CH16																																
CH1	CH2	CH3	CH4																																														
CH5	CH6	CH7	CH8																																														
CH9	CH10	CH11	CH12																																														
CH13	CH14	CH15	CH16																																														
<div style="display: flex; justify-content: flex-end; gap: 10px;"> CANCEL BACKUP </div>																																																	

Step1: In **SOURCE**, choose the data type (VIDEO or LOG) and the time range you want to copy from the calendar. The date with video recording will be shown in blue.

Step2: In **CHANNEL**, choose the channel(s) you want.

Step3: The video footage can only be saved to a USB device. Specify where to save in the USB device in **STORAGE**.

Step4: Choose **BACKUP** to start. The backup video will be in the AVI format.

6. MAIN MENU









6.1 CAMERA

6.1.1 CONNECTION

To know how to add our brand's IP cameras automatically, please refer to "2.3 Camera IP Configurations by LAN" at 7.

To manually add a camera connected locally or remotely, click  to enter the setup page.

Note: Before connecting other brand's IP camera, make sure its IP address is set to 10.1.1.xx (xx ranges from 11 ~ 253). To know how to change the IP address of the camera, please refer to its user manual.

CONNECTION											
EDIT	<input type="checkbox"/> ENABLE	CHANNEL TITLE	URI	PORT	DEVICE TYPE	VENDOR	MODEL	STREAM PROTOCOL	METHOD	PATH1	PATH2
 	<input type="checkbox"/>	CH1	10.1.1.11	88	IPCAM			RTP-Unicast	HTTP		
 	<input type="checkbox"/>										
 	<input type="checkbox"/>										
 	<input type="checkbox"/>										

In the setup page, enter the access information of the camera, and click **APPLY** to confirm.

VENDOR	ONVIF	<input type="button" value="v"/>
MODEL		
STREAM PROTOCOL	RTP-Unicast	<input type="button" value="v"/>
METHOD	TCP	<input type="button" value="v"/>
URI	10.1.1.22	
PORT	82	
PATH1		
PATH2		
USER NAME	test1234	
PASSWORD	•••••	
<input type="button" value="CANCEL"/>		<input type="button" value="APPLY"/>

6.1.2 DEVICE

DEVICE															
CHANNEL TITLE	INTERFACE	ENABLE	CACHE TIME (MSEC)	PORT FORWARD		CAMERA TYPE		ALARM OUT		OSD TITLE		OSD LOGO			
				<input type="checkbox"/>	81	AUTO	<input type="checkbox"/>	3	<input type="checkbox"/>	UP LEFT	<input type="checkbox"/>	UP LEFT			
CH1	IPCAM	<input type="checkbox"/>		<input checked="" type="checkbox"/>	81	AUTO	<input type="checkbox"/>	3	<input type="checkbox"/>	<input checked="" type="checkbox"/>	UP LEFT	<input type="checkbox"/>	<input checked="" type="checkbox"/>	UP LEFT	
CH2	IPCAM	<input type="checkbox"/>		<input checked="" type="checkbox"/>	82	AUTO	<input type="checkbox"/>	3	<input type="checkbox"/>	<input checked="" type="checkbox"/>	UP LEFT	<input type="checkbox"/>	<input checked="" type="checkbox"/>	UP LEFT	
CH3	IPCAM	<input type="checkbox"/>		<input checked="" type="checkbox"/>	83	AUTO	<input type="checkbox"/>	3	<input type="checkbox"/>	<input checked="" type="checkbox"/>	UP LEFT	<input type="checkbox"/>	<input checked="" type="checkbox"/>	UP LEFT	
CH4	IPCAM	<input type="checkbox"/>		<input checked="" type="checkbox"/>	84	AUTO	<input type="checkbox"/>	3	<input type="checkbox"/>	<input checked="" type="checkbox"/>	UP LEFT	<input type="checkbox"/>	<input checked="" type="checkbox"/>	UP LEFT	
													APPLY		

1) CHANNEL TITLE

Click to revise the channel title (up to 63 characters). The default title is the channel number.

2) INTERFACE

Here shows how the camera is connected to this device: IPCAM.

3) ENABLE

Here shows the functions you can enable or disable:

Note: The icons available depend on the camera you connected.

Icon	Meaning	Description
	Time stamp on / off	Display the recording time or not.
	Edge recording on / off	Enable this function to allow video recording directly to the microSD card inserted in the IP camera when the NVR is disconnected to the camera and unable to work properly.
	Recording transfer on / off	When edge recording is on, enable this function to allow the video saved in the microSD card of the camera transferring to the NVR when the NVR is reconnected to the camera and work properly.
	Audio recording on / off	Enable or disable audio recording for the selected channel if the connected camera supports audio recording.

4) CACHE TIME (MSEC)

Drag the slide bar to change the cache time which determines the buffering time of playback.

Note: To speed up the camera's operation, especially for the PTZ camera, you may set the CACHE TIME (MSEC) as zero, but this change may debase the transmission quality.

5) PORT FORWARD

This function is used when you only want to see a single channel of this recorder remotely.

a) Set the port number for the channel in PORT FORWARD. The default value for CH1 is 81, and the default value for CH2 is 82... etc. If you want to change the port number to other value, the range is from 1 ~ 65535.

b) Switch to to enable port forwarding.

The address of the channel will be "http://recorder_address:port_number". Enter the address in Internet Explorer, and see if you can access the device connected channel individually.

Note: The user name and password are still required to access the device connected to the channel. Make sure you know the user name and password to access the device. For details, please refer to its user manual.

6) CAMERA TYPE

Here shows the camera type which is detected automatically.

7) ALARM OUT *(Depending on the camera you connected)*

This function is used to set how long the device should work in seconds when the  is clicked on the camera channel.

Note: An alarm-out device (such as a buzzer) should be connected to the IP camera first for this function to take effects.

5.1.3 IMAGE













Click  to manually adjust the brightness / contrast / saturation / hue by channel.

IMAGE					
EDIT	CHANNEL TITLE	BRIGHTNESS	CONTRAST	SATURATION	HUE
	CH1	128	128	140	128
	CH2	128	128	140	128
	CH3	128	128	140	128
	CH4	128	128	140	128

6.1.4 DETECTION

DETECTION							
CHANNEL TITLE	ALARM		INTERNAL ALARM	SENSITIVITY	MOTION	AREA	ADVANCED CONFIG
CH1	OFF	▼	ON		ON	EDIT	
CH2	N.C.	▼	OFF		OFF	EDIT	
CH3	N.O.	▼	OFF		OFF	EDIT	
CH4	OFF	▼	OFF		OFF	EDIT	
							APPLY

1) ALARM

Select **N.C.** / **N.O.** depending on your installation need. The default alarm value is **OFF**.

2) INTERNAL ALARM

Select if you want to activate the PIR detection function for the selected channel (**ON** / **OFF**).

Note: This option is available only when the camera you connected has a PIR sensor built-in.

3) SENSITIVITY

Select the detection sensitivity of the selected channel. **2** is the highest sensitivity.

4) MOTION

Select if you want to activate the motion detection function for the selected channel (**ON** / **OFF**).

5) AREA

Click **EDIT** to set the motion detection area.

There are 16 × 12 grids per camera for all channels. Pink blocks represent the area that is not being detected while the transparent blocks are the area under detection.



Note: To exit area setting and return to the detection page, right click your mouse.

6) ADVANCED CONFIG

The advanced settings are available only when the connected camera supports.

■  Privacy mask

You can cover certain areas on the camera image with privacy masks. Up to 20 areas could be added.

PRIVACY MASK					
MOSAIC SIZE					8x8
NAME	FUNCTION	MOSAIC	COLOR	MOSAIC COLOR	TRANSPARENCY
MASK1	OFF	OFF	ON		0%
MASK2	ON	ON	ON		25%

ADD

EDIT

DEL

Select **ADD** to add a new setting, **EDIT** to modify an existing setting, and **DEL** to remove a setting.

PRIVACY MASK - EDIT	
NAME	MASK3
FUNCTION	ON
MOSAIC	ON
COLOR	ON
MOSAIC COLOR	
TRANSPARENCY	50%
MASK AREA	SETUP

Item	Description
MOSAIC SIZE	Choose the mosaic size of the privacy mask. The options are: 8x8, 32x32, and 64x64.
NAME	Name your privacy mask.
FUNCTION	Select "On" to enable the privacy mask function.
MOSAIC	Select "ON" to have the mosaic effect.
COLOR	Select "ON" to color the privacy mask. In the meantime, you can't see the mosaic effect.
MOSAIC COLOR	Select the color for the privacy mask.
TRANSPARENCY	Select the transparency for your privacy mask. The options are: 0%, 25%, 50%, and 100%.
MASK AREA	Select "SETUP" to enter the area selection page. To exit, right click.

■  ROI (Region of Interest)

ROI is used to reinforce the image quality of the selected area(s). Users could specify two areas in the camera view.

REGION OF INTEREST		
REGION	ENABLE	QUALITY
1	ON	7
2	OFF	7

EDIT

Select **REGION 1** or **REGION 2**, and choose **EDIT** to change the setting.

REGION OF INTEREST - EDIT	
ENABLE	ON
QUALITY	
AREA	SETUP

APPLY

■  Camera Guard

This function is used to lock the camera to a fixed point and no pan action could be made until the lock mode is disabled. Before using this function, make sure:

1. You've configured at least one preset point and one preset group for the connected camera. To know how to configure preset points and preset group, please refer to "" at page .
2. You have an iOS or android mobile device with our free app, EagleEyes, installed.
3. Your recorder is connected to Internet, and registered in the address book of EagleEyes.

CAMERA GUARD – CH1	
GUARD LOCK	ON
TIMEOUT (SECS)	30 <input type="checkbox"/>
PRESET GROUP	1 <input type="checkbox"/>
PRESET NUMBER	1 <input type="checkbox"/>
<input type="button" value="APPLY"/>	

Item	Description
GUARD LOCK	Enable (ON) or disable (OFF) this function.
TIMEOUT (SECS)	Configure the timeout in seconds (30 / 60 / 90 / 120) after which the camera will be fixed to the current point and any attempt to pan the camera to another point will be failed.
PRESET GROUP	Choose the group where the point you'd like to use is configured, and go to PRESET NUMBER to choose the preset point number.
PRESET NUMBER	Choose the preset point number you'd like to use when GUARD LOCK is enabled.

6.2 RECORD

Set the image size, video quality and other related parameters individually for live display, record streaming and sub streaming.

Note: The settings shown below depend on the setting tab you selected in this setting page.

- a) **D.O.R** (Depend on record): When this option is checked, the video size, quality and other related parameters will follow the configurations in **RECORD STREAM**.
- b) **PROFILE**: Select the video profile pre-defined in your IP cameras. You can directly use the profile setting, or modify the setting on this page.
- c) **TYPE**: Select the compression format for each channel.

Note: The options selectable for **TYPE** depend on the camera you're intended to connect.

- d) **IMAGE SIZE**: Select the image size for each channel.

Note: The options selectable for **IMAGE SIZE** depend on the camera you're intended to connect.

- e) **QUALITY**: Select the video quality for each channel. The higher the value, the better the image quality.
- f) **I.P.S.**: Image per Second, the higher the value, the more fluent the video.

Note: The options selectable for "I.P.S." depends on the camera you're intended to connect.

- g) **BITRATE (kbps)**: Select how much data to process per unit of time for each channel. The higher the value, the better the video quality.
- h) **BITRATE CONTROL**: Configure the upper bit rate limit for the selected channel if necessary.
VBR - When the bit rate of the camera exceeds the value you set, the video fluency may be affected;
CBR - When the bit rate of the camera exceeds the value you set, the image quality may be affected.
- i) **G.O.V.**: "Group of VOPs" is used to configure the length of G.O.V. The greater of the value, the less the bandwidth for transmission, and the poorer the image quality.

■ LIVE

VIDEO SOURCE CONFIG												
LIVE	RECORD STREAM	SUBSTREAM										
CHANNEL	D.O.R	PROFILE	TYPE	IMAGE SIZE		QUALITY	I.P.S.		BITRATE (kbps)	BITRATE CONTROL	G.O.V.	
CH1	<input type="checkbox"/>	PROFILE-3	▼ H265	▼	720 X 480	▼		30	▼	2048	VBR	30
CH2	<input type="checkbox"/>	PROFILE-3	▼ H264	▼	1280 x 1024	▼		30	▼	2048	VBR	30
CH3	<input type="checkbox"/>	PROFILE-3	▼ H264	▼	1280 x 1024	▼		30	▼	2048	VBR	30
CH4	<input type="checkbox"/>	PROFILE-3	▼ H264	▼	1280 x 1024	▼		30	▼	2048	VBR	30
											APPLY	

■ RECORD STREAM

VIDEO SOURCE CONFIG												
LIVE	RECORD STREAM	SUBSTREAM										
PROFILE-1												
CHANNEL		PROFILE	TYPE	IMAGE SIZE		QUALITY	I.P.S.		BITRATE (kbps)	BITRATE CONTROL	G.O.V.	
CH1		PROFILE-3	▼ H265	▼	720 X 480	▼		30	▼	2048	VBR	30
CH2		PROFILE-3	▼ H264	▼	1280 x 1024	▼		30	▼	2048	VBR	30
CH3		PROFILE-3	▼ H264	▼	1280 x 1024	▼		30	▼	2048	VBR	30
CH4		PROFILE-3	▼ H264	▼	1280 x 1024	▼		30	▼	2048	VBR	30
											APPLY	

























■ SUB STREAM

VIDEO SOURCE CONFIG												
LIVE	RECORD STREAM	SUBSTREAM										
CHANNEL		PROFILE	TYPE	IMAGE SIZE		QUALITY	I.P.S.		BITRATE (kbps)	BITRATE CONTROL	G.O.V.	
CH1		PROFILE-3	▼ H265	▼	720 X 480	▼		30	▼	2048	VBR	30
CH2		PROFILE-3	▼ H264	▼	1280 x 1024	▼		30	▼	2048	VBR	30
CH3		PROFILE-3	▼ H264	▼	1280 x 1024	▼		30	▼	2048	VBR	30
CH4		PROFILE-3	▼ H264	▼	1280 x 1024	▼		30	▼	2048	VBR	30
											APPLY	

6.3 SCENARIO

This function allows you to customize a series of actions which will be run automatically after the specified event occurs.

Several scenario rules are pre-defined for you to quickly choose and apply. If none of these rules are suitable for you, you can choose  to create your own rule from several scenario templates.

SCENARIO					
EDIT	NAME	TRIGGER	ACTION	TIMER	STATUS
 	MOTION RECORD	ALL CHANNELS	START RECORDING EVENT CHANNEL		OFF
 	ALARM RECORD	ALL CHANNELS	START RECORDING EVENT CHANNEL		OFF
 	GUARD RECORD	GUARD	START RECORDING ALL CHANNELS		ON
 	PUSH VIDEO NOTIFICATIONS (PIR)	GUARD,MOTION(CH1), PIR(CH1)...	PUSH VIDEO TO SEE PLAYBACK		ON
 	PUSH VIDEO NOTIFICATIONS (ALARM)	GUARD,MOTION(CH1),ALARM(CH1)...	PUSH VIDEO TO SEE PLAYBACK		ON
 	MANUAL RECORD		START RECORDING ALL CHANNELS	EVERYDAY	ON
 	PUSH STATUS	ALL SYSTEM STATUSES	PUSH STATUS	EVERYDAY	ON
 	EVENT POP-UP ON LIVE MONITOR (MOTION & ALARM)	MOTION(ALL CHANNELS),ALARM(ALL CHANNELS)	POP UP EVENT ON LIVE MONITOR		ON
 	GUARD ON (MOTION DETECTION)	GUARD			ON
 	GUARD ON (PIR DETECTION)	GUARD			ON
 	GUARD OFF (MOTION DETECTION)	GUARD			ON
 	GUARD OFF (PIR DETECTION)	GUARD			ON
 	EVENT POP-UP ON EVENT MONITOR (MOTION & ALARM)	MOTION(ALL CHANNELS),ALARM(ALL CHANNELS)	PLAYBACK VIDEO ON EVENT MONITOR		ON
					

6.3.1 Pre-defined Scenarios

There are 13 pre-defined scenarios for you to quickly enable the recording and notification functions which are used frequently.

Note: All pre-defined scenarios are not editable. If any changes should be made to suit your need, please add a scenario rule manually.

1) MOTION RECORD

All channels are selected in this rule. The recorder starts recording the channel which has a motion event.
Scenario template used: **ONE OF (EVENT) TO (RECORD)**.

2) ALARM RECORD

All channels are selected in this rule. The recorder starts recording the channel which has an alarm event.
Scenario template used: **ONE OF (EVENT) TO (RECORD)**.

Note: The alarms here refer to the alarm devices connected to the IP cameras or the NVR. For the alarm events triggered by the PIR sensor built into the camera, please choose PIR instead.

3) GUARD RECORD

When **Guard** is enabled from EagleEyes, our mobile app, the recorder starts recording all channels.
Scenario template used: **ONE OF (EVENT) TO (RECORD)**.

4) PUSH VIDEO TRIGGERED BY BUILT-IN PIR SENSOR

When motion & PIR events occur simultaneously, you'll receive Push Video on your mobile device.
Scenario template used: **ALL OF (EVENTS) TO DO (ACTION) AND THEN (ACTION)**.

Note: To know how to enable Push Video, please refer to "APPENDIX 2 PUSH VIDEO CONFIGURATION" at page 58.

5) PUSH VIDEO TRIGGERED BY EXTERNAL ALARM

When motion & alarm events occur simultaneously, you'll receive Push Video on your mobile device.

Scenario template used: **ALL OF (EVENTS) TO DO (ACTION) AND THEN (ACTION)**.

Note: The alarms here refer to the alarm devices connected to the IP cameras or the NVR. For the alarm events triggered by the PIR sensor built into the camera, please choose PIR instead.

Note: To know how to enable Push Video, please refer to "APPENDIX 2 PUSH VIDEO CONFIGURATION" at page 58.

6) MANUAL RECORD

All channels are selected in this rule. The recorder starts recording all channels at the specified time.

Scenario template used: **START (RECORD) AT (TIME)**.

7) SEND PUSH STATUS FOR HEALTH CHECK

All system health events are selected in this rule. When one of the health events occurs at the specified time range, you'll receive Push Status on your mobile device.

Scenario template used: **ONE OF (HEALTH EVENT) OCCURRED AT (TIME) TO SEND PUSH STATUS**.

8) POP-UP ON LIVE MONITOR (MOTION AND EXTERNAL ALARM EVENT)

All channels are selected in this rule. When any motion or alarm event occurs, you'll see pop-up messages on the right pane (Event List) of the monitor.

Scenario template used: **ONE OF (EVENT) TO DO (ACTION)**.

Note: The alarms here refer to the alarm devices connected to the IP cameras or the NVR. For the alarm events triggered by the PIR sensor built into the camera, please choose PIR instead.

9) MOTION DETECTION ON WHEN GUARD ON

All channels are selected in this rule. When **Guard** is enabled from EagleEyes, our mobile app, the motion detection of all channels is also enabled automatically.

Scenario template used: **ONE OF (EVENT) TO DO (ACTION)**.

Note: Motion detection and alarm / PIR detection are two essential elements to trigger Push Video.

10) INTERNAL ALARM (PIR) DETECTION ON WHEN GUARD ON

All channels are selected in this rule. When **Guard** is enabled from EagleEyes, our mobile app, the PIR detection of all channels is also enabled automatically.

Scenario template used: **ONE OF (EVENT) TO DO (ACTION)**.

Note: The alarms here refer to the alarm devices connected to the IP cameras or the NVR. For the alarm events triggered by the PIR sensor built into the camera, please choose PIR instead.

11) MOTION DETECTION OFF WHEN GUARD OFF

All channels are selected in this rule. When **Guard** is disabled from EagleEyes, our mobile app, the motion detection of all channels is also disabled automatically.

Scenario template used: **ONE OF (EVENT) TO DO (ACTION)**.

12) INTERNAL ALARM (PIR) DETECTION OFF WHEN GUARD OFF

All channels are selected in this rule. When **Guard** is disabled from EagleEyes, our mobile app, the motion detection of all channels is also disabled automatically.

Scenario template used: **ONE OF (EVENT) TO DO (ACTION)**.

13) PLAYBACK ON EVENT MONITOR (MOTION & EXTERNAL ALARM EVENT)

All channels are selected in this rule. When any motion or alarm event occurs, you'll see video playback on the monitor you set for **HDMI2 DISPLAY**.

Scenario template used: **ONE OF (EVENT) TO DO (ACTION)**.

Note: You'll also need to manually choose **EVENT MONITOR** and configure related settings in **DISPLAY → HDMI2 DISPLAY**. For details, please refer to "6.10 DISPLAY" at page 46.

6.3.2 Scenario Customization

Click  and choose a template where you can press the button of **EVENT**, **RECORD**, **TIME** or **ACTION** to customize all your events and further actions:

1. ONE OF (**EVENT**) TO (**RECORD**)
2. ONE OF (**EVENT**) AT (**TIME**) TO DO (**ACTION**) AND THEN (**ACTION**)
3. AT (**TIME**) TO DO (**ACTION**) AND THEN (**ACTION**)
4. ALL OF (**EVENTS**) TO DO (**ACTION**) AND THEN (**ACTION**)
5. (**EVENTS**) TO TRIGGER (**RECORD**)
6. START (**RECORD**) AT (**TIME**)
7. ONE OF (**HEALTH EVENT**) OCCURRED AT (**TIME**) TO SEND PUSH STATUS
8. ONE OF (**EVENT**) TO DO (**ACTION**) AND THEN (**ACTION**)
9. ONE OF (**EVENT**) TO DO (**ACTION**)

EVENT



Up to 5 events could be added to the event list when you click the **EVENT** button.

Option		Description
MOTION and ALARM	MOTION	Choose at least one channel which has enabled motion detection.
	ALARM	Choose at least one channel which has connected to our brand's camera and an alarm sensor is connected to the camera.
	PIR	Choose at least one channel which has connected our brand's camera with a PIR sensor built-in.
IVS	FLOW COUNTING IN	Choose at least one channel which has enabled flow counting / one way / virtual fence / scene change depending on the option you've chosen.
	FLOW COUNTING OUT	
	ONE WAY PASS	
	VIRTUAL FENCE	
	CAMERA SCENE CHANGE	
HEALTH CHECK	LOGIN LOCKED	Choose at least one status that you want to pay attention to.
	SYSTEM ERROR	
	VIDEO LOST	
	VIDEO PLUGIN	
	NET LOGIN	
	POWER ON	
	UPS POWER LOST	
	UPS POWER RECOVERED	
	WAN UNPLUGGED	
	WAN PLUGIN	
	INTERNET CONNECTED	
	LAN PLUGGED	
	LAN PLUGIN	
	HDD CLEAN	
	HDD OVER TEMPERATURE	
	NO HDD EXIST	
	KEY UNLOCKED	
FAN BROKEN		
FAN REPAIRED		
GUARD	GUARD	Enable or disable Push Video.

RECORD

Option		Description
START RECORDING EVENT CHANNEL	GROUP	Choose the record profile group you want defined in MENU → RECORD → RECORD STREAM when event recording is on.

TIME

Option		Description
EVERYDAY		Choose the pre-defined time range within which you want to activate the scenario rule.
HOLIDAY		
WEEKDAY		
		Click  to customize the time range within which you want to activate the scenario rule.

ACTION

Up to 5 actions could be added to the action list when you click the **ACTION** button to combine a series of actions you'd like to have.

Option		Description
RECORDER	RECORD	Choose at least one channel to start recording, and the record profile to use when recording is on.
	RESTORE RECORD PROFILE	Restore the record profile group when the specified action is off.
	SET RECORD PROFILE	Choose the record profile group defined in MENU → RECORD → RECORD STREAM .
	START RECORDING EVENT CHANNEL	Choose the record profile group defined in MENU → RECORD → RECORD STREAM which is used for event-channel recording.
	STOP RECORDING EVENT CHANNEL	
	START RECORDING ALL CHANNELS	Choose the record profile group defined in MENU → RECORD → RECORD STREAM which is used for all-channel recording.
	STOP RECORDING ALL CHANNELS	
NOTIFICATION	PUSH VIDEO TO SEE PLAYBACK	When Push Video is received on the mobile device, slide to see event playback.
	PUSH VIDEO TO SEE LIVE	When Push Video is received on the mobile device, slide to see live images.
	PUSH MESSAGE	Enter the message you want to see on your mobile device when an event occurs.
	PUSH STATUS	Send Push Status to your mobile device.
	POP UP EVENT ON LIVE MONITOR	Choose at least one channel to show event icons, notifications and playback preview on the right pane of the live display.
	PLAYBACK VIDEO ON EVENT MONITOR	Choose at least one channel to show its event recording when an event occurs on the event monitor you configured in MENU → DISPLAY .
	VIDEO MAIL	You can choose to receive notifications by Email in four ways: 1. Event videos 2. Snapshots 3. Abnormal status 4. Text Make sure at least a recipient is selected in RECEIVER and configure the related settings in each setting page.
	EMAIL SNAPSHOT	
	EMAIL STATUS	
	EMAIL TEXT	
UPLOAD VIDEO TO FTP	You can choose to upload event videos or snapshots to the FTP site pre-defined in MENU → NETWORK → FTP . Make sure at least an FTP site is selected in PROFILE , and configure the related settings in each setting page.	
UPLOAD SNAPSHOT TO FTP		

Option		Description
CAMERA	PRESET	Choose the channel with a speed dome camera connected, and choose a preset point you want the camera to move to. To know how to set a preset point, please refer to "5.4 PTZ Control" at page 20.
	AUTO TRACKING	Choose the channel with a speed dome camera connected, and the camera supports auto tracking.
	CAMERA GUARD	Choose the channel with our brand's speed dome camera or motorized-pan camera connected, and enable this function to move the camera view to the preset point you specified. To know how to use this function, please refer to "ADVANCED CONFIG" in "6.1.4 DETECTION" at page 25.
	ENABLE MOTION	Choose at least one channel you want to enable motion detection.
	ENABLE PIR	Choose the channel with our brand's PIR camera connected.
I/O	RECORDER ALARM OUT	Choose to automatically activate the alarm-out device connected to the recorder.
	CAMERA ALARM OUT	Choose the channel with our brand's IP camera connected, and an alarm-out device (such as a buzzer) is connected to the camera. This option will automatically activate the alarm-out device connected to the camera.
	BUZZER	Choose to activate the buzzer built in the recorder to alert you.
MISC	DELAY	Set a timeout between each action.

6.4 IVS

This function is available only when the connected IP camera supports this function.

IVS						
	IVS MODE	DISPLAY LINE	SCENE CHANGE	SCENE CHANGE LEVEL	SENSITIVITY	
CH1	FLOW COUNTING <input type="checkbox"/>	OFF	OFF	MIDDLE <input type="checkbox"/>		
CH2						
CH3	ONEWAY <input type="checkbox"/>	OFF	OFF	MIDDLE <input type="checkbox"/>		
CH4						

1) IVS MODE

Select one of the following three modes depending on your environment:

MODE	DESCRIPTION
FLOW COUNTING	A virtual detection line is set to detect the moving direction of pedestrians for flow counting.
VIRTUAL FENCE	A virtual detection line is set to detect intruders crossing the detection line, and an alarm will be triggered.
ONE WAY	A virtual detection line is set to detect intruders from the specified direction, and an alarm will be triggered.

2) DISPLAY LINE

Select to display the detection line for IVS on the screen or not.

3) SCENE CHANGE

Select **ON** to trigger a motion event when the camera is sensed to be moved and the camera scene is changed. At the same time, the icon " " will be also shown on the screen in addition to the motion icon " ".

4) SCENE CHANGE SENSITIVITY

Set the detection sensitivity for **SCENE CHANGE** to **HIGH**, **MIDDLE** or **LOW**.

5) SENSITIVITY

Set the sensitivity for IVS from **0** ~ **15**. The larger the value, the more sensitive the IVS will be.

6) DISPLAY LINE

Select to display the detection line for IVS on the screen or not.

7) (Clear) & (Edit)

Select to clear the flow counting number, and to enter the setting page to set the detection line. For details, please refer to the next section, "IVS Application".

IVS APPLICATION

➤ **FLOW COUNTING**

Step1: Click  to enter the setting page and draw a detection line with your mouse, and decide the detection direction by selecting **REVERSE**.



Step2: Click **APPLY** to finish the IVS setting and return to the live view.

When anyone walks across the detection line, the system will determine his movement is in or out, and add one count to the corresponding channel on the flow counting panel.

IN	People coming from the opposite direction to the arrow mark.
OUT	People coming from the same direction as the arrow mark.





➤ **VIRTUAL FENCE and ONE WAY**

Step1: Click  to enter the setting page and draw a detection line with your mouse, and decide the detection direction by selecting **REVERSE**.



Step2: Click **APPLY** to finish the IVS setting and return to the live view.

When anyone walks across the detection line, the system will determine his movement is in or out, and:

VIRTUAL FENCE	An event happens for anyone walking across the detection line, and “  ” will be shown on the screen.
ONE WAY	An event happens for anyone walking from the opposite direction to the arrow mark, and “  ” will be shown on the screen.





6.5 EXPORT

6.5.1 BACKUP

Note: Before using your USB flash drive for video backup, please format it to "FAT32" first with your PC or laptop. For the list of compatible USB flash drives, please refer to "APPENDIX 3 COMPATIBLE USB FLASH DRIVE LIST at page 61.

Note: Video backup could be made via a USB flash drive or the Internet. It's **NOT** allowed to connect the hard disk to your PC / laptop directly for it may impair the recorded data saved in the hard disk.

To copy recorded data for video backup, click  to add an item for backup. You can add several items to copy different data you need.

BACKUP						
 						
<input type="checkbox"/> SELECT	TIME	CHANNEL	BACKUP TYPE	TOTAL SIZE	DEVICE	STATUS
<input type="checkbox"/>	2017/07/18 23:03:52 ~ 2017/07/18 23:03:52	CH1	VIDEO	321MB	USB DEVICE	25%

BACKUP

SOURCE

DATA TYPE VIDEO LOG

RANGE 2017/07/18 23:03:52 ~ 2017/07/18 23:03:52

< 2017 >	SUN	MON	TUE	WED	THU	FRI	SAT
	2	3	4	5	6	7	8
	9	10	11	12	13	14	15
	16	17	18	19	20	21	22
< JUL >	23	24	25	26	27	28	29
	30	31					

< 23:03:52 > HR MIN SEC

HOURS

DESTINATION

TARGET USB DEVICE

AVAILABLE SIZE 3 GB

STORAGE

USB PATH /VIDEO ...

CHANNEL ALL

CH1	CH2	CH3	CH4
CH5	CH6	CH7	CH8
CH9	CH10	CH11	CH12
CH13	CH14	CH15	CH16

Step1: In **SOURCE**, choose the data type (VIDEO or LOG) and the time range you want to copy from the calendar. The date with video recording will be shown in blue.

Step2: In **CHANNEL**, choose the channel(s) you want.

Step3: The video footage can only be saved to a USB device. Specify the where to save in the USB device in **STORAGE**.

Step4: Choose **BACKUP** to start. The backup video will be in the AVI format.

6.5.2 SCHEDULE

This function is used to schedule video backup regularly, uploading security footages to a FTP site (remotely) or saving to an USB device connected to this device (locally).

You can configure up to 7 profiles and use one of them as your backup preference.

BACKUP																	
<p>SOURCE</p> <p>PROFILE: SCHEDULE1 <input type="button" value="v"/></p> <p>ACTIVE: ON</p> <p>RESOLUTION: RECORD STREAM <input type="button" value="v"/></p> <p>EXECUTION PERIOD: DAILY <input type="button" value="v"/></p> <p>EXECUTION TIME: MON 01</p> <p>RANGE: MON 08 : 00 ~ FRI 19 : 00</p>	<p>DESTINATION</p> <p>TARGET: FTP <input type="button" value="v"/></p> <p>STORAGE</p> <p>FTP PROFILE: Profile1 <input type="button" value="v"/></p> <p>FTP PATH: /VIDEO</p>																
→																	
<p>CHANNEL <input type="checkbox"/> ALL</p> <table border="1" style="width: 100%; border-collapse: collapse; text-align: center;"> <tr> <td style="background-color: #00aaff; color: white;">CH1</td> <td>CH2</td> <td style="background-color: #00aaff; color: white;">CH3</td> <td>CH4</td> </tr> <tr> <td>CH5</td> <td>CH6</td> <td>CH7</td> <td>CH8</td> </tr> <tr> <td>CH9</td> <td>CH10</td> <td>CH11</td> <td>CH12</td> </tr> <tr> <td>CH13</td> <td>CH14</td> <td>CH15</td> <td>CH16</td> </tr> </table>		CH1	CH2	CH3	CH4	CH5	CH6	CH7	CH8	CH9	CH10	CH11	CH12	CH13	CH14	CH15	CH16
CH1	CH2	CH3	CH4														
CH5	CH6	CH7	CH8														
CH9	CH10	CH11	CH12														
CH13	CH14	CH15	CH16														
<input type="button" value="APPLY"/>																	

- Step1: In **SOURCE**, choose the profile you'd like to save all the settings configured in **SOURCE**.
 Choose the video resolution (**SUBSTREAM / RECORD STREAM**), how often and when you'd like the backup to execute (**EXECUTION PERIOD / EXECUTION TIME**), and the time which includes the recordings you want (**RANGE**).
- Step2: In **CHANNEL**, choose the channel(s) you want.
- Step3: In **DESTINATION**, choose where you want to save the data, in a USB flash drive (**USB DEVICE**) or on FTP (**FTP**).
- Step4: (Optional) If **FTP** is chosen in **DESTINATION**, go to **STORAGE**, and choose the profile you'd like to save the storage path configured in **FTP PATH**.
 Then, specify the directory where you'd like the recordings to be uploaded in **FTP PATH**.
- Step5: Click **APPLY** to confirm.

6.5.3 REGULAR REPORT

This function is used to send event reports to the specified E-mail address. Users could configure up to 5 profiles to receive different reports about specific channels at different time.

Note: This function is available only when a hard disk is installed, and the recorder is connected to Internet.

You can configure up to 7 profiles and use one of them as your backup preference.

BACKUP

<p>SOURCE</p> <p>PROFILE: PROFILE1 <input type="button" value="v"/></p> <p>ACTIVE: ON</p> <p>EXECUTION PERIOD: WEEKLY <input type="button" value="v"/></p> <p>EXECUTION DAY OF WEEK: MON <input type="button" value="v"/></p> <p>EXECUTION HOUR: 1 <input type="button" value="v"/></p>	<p>DESTINATION</p> <p>EVENT TYPE: 4 SELECTED <input type="button" value="v"/></p> <table border="1" style="width: 100%; border-collapse: collapse;"> <tr> <td style="width: 15%; text-align: center;">EDIT</td> <td style="text-align: center;">E-MAIL ADDRESS</td> </tr> <tr> <td style="text-align: center;"> <input type="button" value="✎"/> <input type="button" value="✖"/> </td> <td style="text-align: center;">tech_support@gmail.com</td> </tr> <tr> <td style="text-align: center;"> <input type="button" value="+"/> <input type="button" value="📄"/> </td> <td></td> </tr> </table>	EDIT	E-MAIL ADDRESS	<input type="button" value="✎"/> <input type="button" value="✖"/>	tech_support@gmail.com	<input type="button" value="+"/> <input type="button" value="📄"/>	
EDIT	E-MAIL ADDRESS						
<input type="button" value="✎"/> <input type="button" value="✖"/>	tech_support@gmail.com						
<input type="button" value="+"/> <input type="button" value="📄"/>							

<p>CHANNEL <input checked="" type="checkbox"/> ALL</p> <table border="1" style="width: 100%; border-collapse: collapse; background-color: #e0ffff;"> <tr><td>CH1</td><td>CH2</td><td>CH3</td><td>CH4</td></tr> <tr><td>CH5</td><td>CH6</td><td>CH7</td><td>CH8</td></tr> <tr><td>CH9</td><td>CH10</td><td>CH11</td><td>CH12</td></tr> <tr><td>CH13</td><td>CH14</td><td>CH15</td><td>CH16</td></tr> </table>	CH1	CH2	CH3	CH4	CH5	CH6	CH7	CH8	CH9	CH10	CH11	CH12	CH13	CH14	CH15	CH16	→
CH1	CH2	CH3	CH4														
CH5	CH6	CH7	CH8														
CH9	CH10	CH11	CH12														
CH13	CH14	CH15	CH16														

Step1: In **SOURCE**, choose the profile you'd like to save all the settings configured in **SOURCE**. Choose how often and when you'd like to receive reports. Finally, make sure this profile is active (**ACTIVE** to **ON**).

EXECUTION PERIOD	Select how often you want to receive reports: MONTHLY , WEEKLY or DAILY .
EXECUTION DAY OF MONTH / EXECUTION DAY OF WEEK	Depending on the option you selected in EXECUTION PERIOD : <ul style="list-style-type: none"> ■ EXECUTION DAY OF MONTH shows when MONTHLY is selected. Select one date from 1 ~ 31 to reboot. ■ EXECUTION DAY OF WEEK shows when WEEKLY is selected. Select one day from Monday ~ Sunday to reboot.

Step2: In **CHANNEL**, choose the channel(s) you want.



Step3: In **DESTINATION**, choose which event type(s) you want to see (**MANUAL / MOTION / ALARM / SYSTEM / TIMER / HUMAN DETECTION**).

Step4: Click to manually add an Email address to receive reports or to select from the E-mail address list pre-defined in **NETWORK → E-MAIL**, to modify the selected Email address, and to remove the selected Email address from the recipients list.

Step5: Click **APPLY** to confirm.

6.6 STORAGE

To copy recorded data for video backup, click  to add an item for backup. You can add several items to copy different data you need.

STORAGE										
HDD NEARLY FULL (GB)								5		▼
HDD OVERHEAT ALERT (°C)								70		▼
OVERWRITE								ON		
KEEP DATA LIMIT(DAYS)								OFF		▼
TEMPERATURE TO ENABLE FAN								30		▼
	ID	TYPE	STATUS	SIZE	TEMP.	SERIAL NUMBER	FREE SIZE	FORMAT TIME	HEALTH STATUS	
  	HDD 5-1	NORMAL	READY	750GB	33°C	WD-WCAV53797317	269.856GB	2017/07/18 23:03:52	GOOD	

1) HDD NEARLY FULL (GB)

If **HDD BUZZER** is enabled in **MAINTAIN**, select the duration time for buzzer notifications when the hard disk available capacity is 5/10/15/20 GB left.

2) HDD OVERHEAT ALERT (°C)

Select the temperature alert for your hard disk to be aware of the possible overheat of your hard disk.

3) OVERWRITE

By default, the HDD overwritten function is set to ON, and  will be shown on the screen.

4) KEEP DATA LIMITS (DAYS)

Assign how many days to save the recording data from **1** to **31** days. After the assigned day(s), the recorded data will be removed. Select **OFF** to disable this function.

5) TEMPERATURE TO ENABLE FAN

Choose the temperature (**25 / 30 / 35 / 40**) to enable the built-in fan to work for heat dissipation.

6) HDD information

You can check the remaining capacity of the connected hard disk in this device and its current status.

If the health status goes to:

- **GOOD** - This hard disk works normal.
- **BELOW AVERAGE** - The hard disk might work with some errors. Please pay attention and do video backup if needed.
- **REPLACEMENT NEEDED** – Please replace this hard disk immediately to ensure continuous video recording.

7)  HDD details



You can check the details of the selected hard disk.

8)  HDD formation

Click to format the selected hard disk and erase all data. When a hard disk is inserted to the recorder for the first time, it's compulsory to format the hard disk for it to work properly.

9)  Mount /  Unmount HDD

HDD hot-swapping is supported for this device. There's no need to power off the device first to install or remove a hard disk.

When a hard disk is installed, you'll need to click  to manually mount the hard disk for it to work properly. When you need to remove a hard disk, click  to unmount the hard disk and you'll be able to remove it.



Note: It's not allowed to remove a hard disk without clicking  first.

6.7 ACCOUNT

Note: This function is available only for **SUPERVISOR**.

6.7.1 USER LIST

This function is used to create a new user account, or modify or delete an existing account for different access privilege.

USER LIST		
EDIT	USER NAME	GROUP
 	admin	SUPERVISOR
		

■ How to create an account

Select , enter a user name and its password, and assign a user group in which includes the access rights you wish to grant to this new account. Then, select **SAVE** to create and return to the user list page.



Note: Four user levels are pre-defined in the system for you to quickly choose: **SUPERVISOR, POWER USER, USER & GUEST**. For details about available operations of each level, please refer to "6.7 ACCOUNT" at page 41.





ADD			
USER NAME	TEST1		
PASSWORD	●●●●●●●●		
CONFIRM PASSWORD	●●●●●●●●		
GROUP	POWER USER 		
<table border="1" style="width: 100%;"> <tr> <td style="width: 50%; text-align: center;">SAVE</td> <td style="width: 50%; text-align: center;">CANCEL</td> </tr> </table>		SAVE	CANCEL
SAVE	CANCEL		

6.7.2 GROUP

This function is used to create a new group with customized user access rights for different functions if needed, and you can create a user account and assign it to your customized group.

Note: The default user groups are **SUPERVISOR**, **POWER USER**, **USER** and **GUEST**, and they're not allowed to be removed. For details about available local operations of each user group, please refer to "6.7 ACCOUNT" at page 41.

BACKUP				
MANAGER	▼			
GENERAL	LOCAL	NETWORK		
BACKUP			ALL	▼
PTZ CONTROL			OFF	
POWER CONTROL			ON	
REVIEW LOG			ON	
CONFIG SETUP			OFF	
CLEAR LOG			OFF	
ACCOUNT SETUP			OFF	
CLEAR HDD			OFF	
PUSH VIDEO			ON	
PUSH STATUS			ON	
ALARM OUT			ON	
				APPLY

Icon	Meaning	Description
	Delete	Choose a customized user group and delete it. The default user groups (SUPERVISOR , POWER USER , USER and GUEST) can't be removed.
	Add	Click to enter a group name, and select the tabs of GENERAL , LOCAL and NETWORK to choose the corresponding functions you want to enable or disable. Then, click APPLY to confirm.
	Import	You need to create a user group first to use this function. Choose one of the default user groups you want to modify for your customized group from the drop-down list and click  choose a customized group to import the configurations. Then, you can quickly modify the configurations and click APPLY to confirm.

6.8 NETWORK

There are two RJ45 ports on the rear panel: **WAN** and **LAN**.

- **WAN** is used to connect this recorder to Internet for remote access from anywhere as long as Internet access is available.
- **LAN** is used to connect to IP cameras locally.
- **DDNS** is used when the Internet access is available.



Note: For more details about these three functions and network configurations, please get the setup manual from www.surveillance-download.com/user/network_setup/network_setup_recorder.pdf.

WAN	WAN	
LAN	NETWORK TYPE	STATIC ▼
DDNS	IP	192.168.1.112
E-MAIL	GATEWAY	192.168.1.254
FTP	NETMASK	255.255.255.0
MULTICASTING	PRIMARY DNS	168.95.1.1
EaZy	SECONDARY DNS	139.175.55.244
	PORT	88
	INTERNET AVAILABILITY ADDRESS	www.google.com
	MAC 00:0E:53:00:13:77	

6.8.1 E-MAIL

Configure your E-mail account here to send event notifications or reports.

Note: To know the SMTP server and port number you should use, please check with your E-mail service provider.

E-MAIL	
SMTP SERVER	SMTP.GMAIL.COM
PORT	465
MAIL FROM	OFFICE_MANAGER@GMAIL.COM
SSL ENCRYPTION	ON
VERIFY PASSWORD	ON
USER NAME	MANAGER
PASSWORD	●●●●●●
EDIT	E-MAIL ADDRESS
 	manager_1@fulltech.com
	

6.8.2 FTP

Configure up to 7 FTP sites here to upload event notifications or reports.

FTP							
FTP 1	FTP 2	FTP 3	FTP 4	FTP 5	FTP 6	FTP 7	
NAME							Profile1
SERVER							211.75.33.2144
PORT							25
USER NAME							office
PASSWORD							●●●●●●
							APPLY

6.8.3 MULTICASTING

In this menu, users could configure the multicast address and port used for each channel for data streaming.

Three streams for different usage could be configured per channel. These are used for different video data requests from different clients.

MULTICASTING									
TIMEOUT (SECS)								50	▼
LIMIT THE TRANSFERING OF THE RECORDING STREAM								2	▼
	MULTICAST STREAM 1 ADDRESS	MULTICAST SREAM 1 PORT	STREAM 1 TIME TO LIVE(TTL)	MULTICAST STREAM 2 ADDRESS	MULTICAST SREAM 2 PORT	STREAM 2 TIME TO LIVE(TTL)	MULTICAST STREAM 3 ADDRESS	MULTICAST SREAM 3 PORT	STREAM 3 TIME TO LIVE(TTL)
CH1	239.0.0.1	9000	15	239.0.0.2	9002	15	239.0.0.3	9004	15
CH2	239.0.0.1	9006	15	239.0.0.2	9008	15	239.0.0.3	9010	15
CH3	239.0.0.1	9012	15	239.0.0.2	9014	15	239.0.0.3	9016	15
CH4	239.0.0.1	9018	15	239.0.0.2	9020	15	239.0.0.3	9022	15

1) TIMEOUT (SECS)

Set the timeout in second for transmission attempt in second for this channel, after which the attempt will be down. The options are: **10 / 20 / 30 / 50 / 120 / 240 / 300**.

2) LIMIT THE TRANSFERING OF THE RECORDING STREAM

Set the number of how many record streaming could be transferred at the same time.

3) MULTICAST STREAM ADDRESS

Configure the addresses used for the three streams per channel.

The address range for multicasting is from 224.0.0.0 to 239.255.255.255.

Note: The address for each stream per channel should be unique and can't be the same as other stream in the same channel or other channel.

4) MULTICAST STREAM PORT

Set the event recording function on / off.

Configure the ports used for the three streams per channel.

The port range is from 1 to 65535.

Note: The port for each stream per channel should be unique and can't be the same as other stream in the same channel or other channel.

5) TIME TO LIVE(TTL)

Set the connection time in second for each stream from 1 ~ 999.

6.8.4 EaZy

This function is used to connect this recorder to Internet by using EaZy Networking. For details, please refer to “APPENDIX 7 EAZY NETWORKING” at page 65.



6.9 TIME

TIME SETUP	
DATE	2009 / NOV / 17
TIME	15 : 35 : 53
FORMAT	Y/M/D
NTP SERVER	Pool.ntp.org
SYNC PERIOD	DAILY
GMT	(UTC+08:00)TAIPEI
CLIENT TIME SYNC VIA NVR WAN	OFF

- 1) DATE
Set the current date. The default display format is YEAR – MONTH – DATE (**Y-M-D**).
- 2) TIME
Set the current time in HOUR : MIN : SEC.
- 3) FORMAT
Set the time display format: **Y/M/D**, **M/D/Y** or **D/M/Y**.
- 4) NTP SERVER
Click to change the default NTP server to another server they're familiar with, or keep the default NTP server.
- 5) SYNC PERIOD
Select to synchronize the device time every day (**DAILY**), or turn this function off (**OFF**).
- 6) GMT
Select your time zone.
- 7) CLIENT TIME SYNC VIA NVR WAN
Enable this function to synchronize the time of the connected IP cameras via the NVR when the NVR is connected to the Internet. This could ensure the time of the NVR and IP cameras are the same to prevent the confusion of time inconsistency.

Note: You may receive NTP-based DDoS attacks when this function is enabled. Please make sure your network is secured to prevent this kind of attack.

6.10 DISPLAY

DISPLAY		
CHANNEL TITLE	ON	
EVENT STATUS	ON	
HDD DISPLAY MODE	RE,MAINING SIZE	▼
DISPLAY OUTPUT	AUTO	▼
LANGUAGE	ENGLISH	▼
HDMI2 DISPLAY	SETUP	
COMPOSITE OUTPUT	SETUP	

- 1) CHANNEL TITLE
Select to display the channel title or not (**ON / OFF**).
- 2) EVENT STATUS
Select to display the event icons or not (**ON / OFF**).

Note: For details about each event icon, please refer to "4.3 Status & Operation" at page 14.

- 3) HDD DISPLAY MODE
Select **REMAINING SIZE** to show the remaining HDD capacity for recording in GB, or **REMAINING TIME** to show the remaining recording time.
- 4) DISPLAY OUTPUT
Select the display resolution you want. The default value is **AUTO**. This is used for the main display output.

Note: To have the best image quality on your monitor, make sure (1) the selected output resolution is supported by your monitor, and (2) the output settings on both the LCD monitor and the recorder are consistent.

If the image is not positioned or scaled properly, please go to your monitor's menu for adjustment. For details, please refer to the user manual of your monitor.

- 5) LANGUAGE
Select the language of the OSD.
- 6) HDMI2 DISPLAY
Specify how the second HDMI port is used for video output: **CALL MONITOR / EVENT MONITOR / LIVE**.

- **CALL MONITOR** is used for sequence display. When this option is selected, go to **CALL SCREEN DURATION** to select the duration time in second (**03 / 05 / 10 / 15**) and **CALL MONITOR PERMIT** to choose the channel(s) you want for sequence display.

HDMI2 DISPLAY		
FUNCTION	CALL MONITOR	▼
CALL SCREEN DURATION	5	▼
CALL MONITOR PERMIT	4 selected	▼

- **EVENT MONITOR** is used when any alarm event occurs. When this option is selected, go to **LAYOUT** to select how many channels you want to see, and **PRE-ALARM (SEC)** and **POST-ALARM (SEC)** to set how many seconds you'd like to see before (**0 ~ 5**) and after (**3 ~ 10**) the event starts.

HDMI2 DISPLAY						
FUNCTION	EVENT MONITOR	▼				
LAYOUT	4	▼				
PRE-ALARM (SEC)	3	▼				
POST-ALARM (SEC)	5	▼				
<table border="1" style="width: 100%; height: 100px;"> <tr> <td style="width: 50%;"></td> <td style="width: 50%;"></td> </tr> <tr> <td style="width: 50%;"></td> <td style="width: 50%;"></td> </tr> </table>						

- **LIVE** is used to select how many channels you'd like to show on the spot monitor.

HDMI2 DISPLAY						
FUNCTION	LIVE	▼				
LAYOUT	4	▼				
<table border="1" style="width: 100%; height: 100px;"> <tr> <td style="width: 50%; text-align: center;"> <div style="border: 1px solid black; padding: 5px; display: inline-block;">CH1 ▼</div> </td> <td style="width: 50%; text-align: center;"> <div style="border: 1px solid black; padding: 5px; display: inline-block;">CH3 ▼</div> </td> </tr> <tr> <td style="width: 50%; text-align: center;"> <div style="border: 1px solid black; padding: 5px; display: inline-block;">CH5 ▼</div> </td> <td style="width: 50%; text-align: center;"> <div style="border: 1px solid black; padding: 5px; display: inline-block;">CH8 ▼</div> </td> </tr> </table>			<div style="border: 1px solid black; padding: 5px; display: inline-block;">CH1 ▼</div>	<div style="border: 1px solid black; padding: 5px; display: inline-block;">CH3 ▼</div>	<div style="border: 1px solid black; padding: 5px; display: inline-block;">CH5 ▼</div>	<div style="border: 1px solid black; padding: 5px; display: inline-block;">CH8 ▼</div>
<div style="border: 1px solid black; padding: 5px; display: inline-block;">CH1 ▼</div>	<div style="border: 1px solid black; padding: 5px; display: inline-block;">CH3 ▼</div>					
<div style="border: 1px solid black; padding: 5px; display: inline-block;">CH5 ▼</div>	<div style="border: 1px solid black; padding: 5px; display: inline-block;">CH8 ▼</div>					

7) COMPOSITE OUTPUT

Specify how the composite port is used for video output: **CALL MONITOR / EVENT MONITOR / LIVE**.

- **CALL MONITOR** is used for sequence display. When this option is selected, go to **CALL SCREEN DURATION** to select the duration time in second (**03 / 05 / 10 / 15**) and **CALL MONITOR PERMIT** to choose the channel(s) you want for sequence display.

COMPOSITE OUTPUT		
FORMAT	NTSC	▼
FUNCTION	CALL MONITOR	▼
CALL SCREEN DURATION	5	▼
CALL MONITOR PERMIT	4 selected	▼

- **EVENT MONITOR** is used when any alarm event occurs. When this option is selected, go to **LAYOUT** to select how many channels you want to see, and **PRE-ALARM (SEC)** and **POST-ALARM (SEC)** to set how many seconds you'd like to see before (**0 ~ 5**) and after (**3 ~ 10**) the event starts.

COMPOSITE OUTPUT						
FORMAT	NTSC	▼				
FUNCTION	EVENT MONITOR	▼				
LAYOUT	4	▼				
PRE-ALARM (SEC)	3	▼				
POST-ALARM (SEC)	5	▼				
<table border="1" style="width: 100%; height: 100px;"> <tr> <td style="width: 50%;"></td> <td style="width: 50%;"></td> </tr> <tr> <td style="width: 50%;"></td> <td style="width: 50%;"></td> </tr> </table>						

- **LIVE** is used to select how many channels you'd like to show on the spot monitor.

HDMI2 DISPLAY						
FORMAT	NTSC	▼				
FUNCTION	LIVE	▼				
LAYOUT	4	▼				
<table border="1" style="width: 100%; height: 100px;"> <tr> <td style="width: 50%; text-align: center;"> <input type="text" value="CH1"/> ▼ </td> <td style="width: 50%; text-align: center;"> <input type="text" value="CH3"/> ▼ </td> </tr> <tr> <td style="width: 50%; text-align: center;"> <input type="text" value="CH5"/> ▼ </td> <td style="width: 50%; text-align: center;"> <input type="text" value="CH8"/> ▼ </td> </tr> </table>			<input type="text" value="CH1"/> ▼	<input type="text" value="CH3"/> ▼	<input type="text" value="CH5"/> ▼	<input type="text" value="CH8"/> ▼
<input type="text" value="CH1"/> ▼	<input type="text" value="CH3"/> ▼					
<input type="text" value="CH5"/> ▼	<input type="text" value="CH8"/> ▼					

6.11 PERIPHERAL

6.11.1 LOCAL

LOCAL																																																					
MOUSE SENSITIVITY	<table style="margin: 0 auto;"> <tr> <td style="border: none;">0</td> <td style="border: none;"> </td> <td style="border: none;"> </td> <td style="border: none;"> </td> <td style="border: none;"> </td> <td style="border: none;"> </td> <td style="border: none;"> </td> <td style="border: none;"> </td> <td style="border: none;"> </td> <td style="border: none;"> </td> <td style="border: none;"> </td> <td style="border: none;"> </td> <td style="border: none;">10</td> </tr> <tr> <td style="border: none;"></td> <td style="border: none;"></td> <td style="border: none;"></td> <td style="border: none;"></td> <td style="border: none;"></td> <td style="border: none;"></td> <td style="border: none;"></td> <td style="border: none;"></td> <td style="border: none;"></td> <td style="border: none;"></td> <td style="border: none;"></td> <td style="border: none;"></td> <td style="border: none;"></td> </tr> <tr> <td style="border: none;"></td> <td style="border: none;"></td> <td style="border: none;"></td> <td style="border: none;"></td> <td style="border: none;"></td> <td style="border: none;"></td> <td style="border: none;"></td> <td style="border: none;"></td> <td style="border: none;"></td> <td style="border: none;"></td> <td style="border: none;"></td> <td style="border: none;"></td> <td style="border: none;"></td> </tr> <tr> <td style="border: none;"></td> <td style="border: none;"></td> <td style="border: none;"></td> <td style="border: none;"></td> <td style="border: none;"></td> <td style="border: none;"></td> <td style="border: none;"></td> <td style="border: none;"></td> <td style="border: none;"></td> <td style="border: none;"></td> <td style="border: none;"></td> <td style="border: none;"></td> <td style="border: none;"></td> </tr> </table>	0												10																																							
0												10																																									
REMOTE CONTROL ID	0																																																				

- 1) **MOUSE SENSITIVITY**
Select the mouse sensitivity. The higher the value, the more sensitive the mouse.
- 2) **REMOTE CONTROL ID**
This function is available when users need to control two or more recorders with one IR remote controller. The ID set here is used to identify the recorder the remote controller is going to control. Please also read the user manual of the IR remote controller for details.

6.11.2 JOYSTICK

In this menu, you can adjust the speed of pan / tilt movement of the speed dome camera or a motorized-pan camera.

Note: To control the movement of the speed dome camera, you can choose  from the PTZ control panel and move on the screen ("5.4 PTZ Control" at page 20), or simply connect the compatible joystick, AVX102, to the DVR.

JOYSTICK	
MAX SPEED OF X AXIS	<input type="text" value="100"/>
MAX SPEED OF Y AXIS	<input type="text" value="100"/>
CURVE ORDER OF X AXIS	1
CURVE ORDER OF Y AXIS	1

6.12 MAINTAIN

6.12.1 SYSTEM

SYSTEM	
BACKUP CONFIG	SUBMIT
RESTORE CONFIG	SUBMIT
RESET DEFAULT	SUBMIT
DEVICE TITLE	nvr_1
ENABLE AUTO PLUG AND PLAY	ON
BIND MAC ADDRESS	OFF

1) BACKUP CONFIG / RESTORE CONFIG

To save the DVR current configurations for later use, such as restoring after DVR upgrade or applying to another DVR, insert a compatible USB flash drive into the USB port, and select **SUBMIT** in **SUBMIT** in **BACKUP CONFIG** to copy the current DVR configurations to a file "System.bin" and save to your USB flash drive.

To restore the DVR configurations, insert the USB flash drive including "System.bin" to the USB port, and select **SUBMIT** in **RESTORE CONFIG**.

2) RESET DEFAULT

Click **SUBMIT** to reset all settings or partial settings to their factory default values, and select **YES** to confirm or **NO** to cancel. The system will reboot after reset.

3) DEVICE TITLE

Enter a title for this device.

4) ENABLE AUTO PLUG AND PLAY

Switch to **ON** to allow the camera to be detected and configured automatically when it's connected to this device.

Note: This function is available only when the brand of the cameras connected is the same as this device.

5) BIND MAC ADDRESS

This function is recommended to be used when your surveillance system is more than 256 cameras. It would be helpful for the system to get the address of each connected camera quickly if the system accidentally shuts down and needs to recover.

6.12.2 UPGRADE

In this menu, you can choose to upgrade your recorder (**LOCAL**) or the connected our brand's IP cameras (**CAMERA**).

LOCAL







Save the upgrade files obtained from your installer or distributor in a compatible USB flash drive, and insert it into the USB port. Then, click **SUBMIT** to start upgrading.

Note: Before using the USB flash drive, please use your PC to format the USB flash drive to FAT32 format first. For the list of compatible USB flash drives, please refer to "APPENDIX 3 COMPATIBLE USB FLASH DRIVE LIST at page 61.

UPGRADE	
LOCAL UPGRADE	CAMERA SUBMIT
VERSION	1002-1001-1001-1000



CAMERA

You can choose to upgrade several connected IP cameras from the recorder as long as the cameras are our brand's IP cameras.

UPGRADE				
LOCAL	CAMERA			
CHANNEL	VERSION	DIRECTORY	STATUS	
CH1	1085-1032-1046-1020-A1A1	/mnt/usb/FullImg-1086-1033-1046-1020.bin		  
CH2	1020S-1007S-1011S-1009S			
CH3				
CH4				
			UPGRADE	COPY TO 

Step1: Save the upgrade files obtained from your installer or distributor in a compatible USB flash drive, and insert it into the USB port.

Step2: Choose  to browse to where the firmware file is saved and choose the file to upgrade. Then, choose **SELECT** to confirm and return to the upgrade page.

	/	USB DEVICE		
NAME	SIZE	TYPE	MODIFIED DATE	
FullImg-1086-1033-1046-1020.bin	27.6MB	regular file	2017-07-13 12:19:32	
FullImg-1022-1007-1011-1009.bin	9.6MB	regular file	2017-08-16 17:05:16	
		CANCEL	SELECT	

Step3: Repeat Step2 as many as needed until all cameras which need firmware upgrade are selected.

If one firmware file applies to several IP cameras, select **COPY TO** to apply the same file to the applicable cameras.

Step4: Choose UPGRADE to start upgrading all selected cameras, or choose  to upgrade the camera one by one.

6.12.3 ALERT

ALERT		
EXT. ALERT		OFF
INT. BUZZER		ON
KEY BUZZER		ON
VLOSS BUZZER		ON
MOTION BUZZER		ON
ALARM BUZZER		ON
HDD BUZZER		ON
ALARM BUZZER DURATION (SEC)	10	▼

1) EXT. ALERT

Select to enable or disable the sound when any external alarm is triggered (**ON / OFF**).

2) INT. BUZZER

Select to enable or disable the sound (**ON / OFF**) for all internal buzzers: **KEY BUZZER, VLOSS BUZZER, MOTION BUZZER, ALARM BUZZER, and HDD BUZZER.**

Note: When this item is set to **OFF**, item 3) to item 7) will be disabled even though they are set to **ON**.

3) KEY BUZZER

Select to enable or disable the sound when pressing the buttons on the front panel (**ON / OFF**).

4) VLOSS BUZZER

Select to enable or disable the sound when video loss happened (**ON / OFF**).

5) MOTION BUZZER

Select to enable or disable the sound when any motion alarm is triggered (**ON / OFF**).

6) ALARM BUZZER

Select to enable or disable the sound when any internal alarm is triggered (**ON / OFF**).

7) HDD BUZZER

Select to enable or disable the sound (**ON / OFF**) when the HDD remaining capacity reaches to the value set in **HDD NEARLY FULL (GB)**.

8) ALARM BUZZER DURATION (SEC)

Select the duration time for alarm buzzer in second (**5 / 10 / 20 / 40**).

6.12.4 EVENT LOG

You can check all the event information (event type, time and channel), or clear all log records.

EVENT LOG					
EVENT	TIME	COMMENT			
KEY UNLOCK	2011/NOV/19 15:49:07				
VIDEO LOSS	2011/NOV/19 15:32:05	04			
POWER ON	2011/NOV/19 15:32:02				
<table border="1" style="margin: auto;"> <tr> <td>PREV</td> <td>NEXT</td> <td>CLEAN</td> </tr> </table>			PREV	NEXT	CLEAN
PREV	NEXT	CLEAN			

6.12.5 ONLINE

ONLINE		
ANONYMOUS VIEWER LOGIN	OFF	
DROP ALL CONNECTION	SUBMIT	
LOGIN FAILURE TIMES	3	▼
LOCK TIME FOR LOGIN FAILURES	10 MINS	▼

1) ANONYMOUS VIEWER LOGIN

Switch to **ON** to allow anonymous login, meaning there's no need to enter user name and password for remote access.

2) DROP ALL VIDEO CONNECTION

Click **SUBMIT** to force disconnection of all remote logins when needed.

3) LOGIN FAILURE TIMES

The recorder will lock the IP address with several login attempts. Choose the failure times of login attempts from the same IP address (**1 ~ 20**), and go to the next option, **LOCK TIME FOR LOGIN FAILURES**, to choose how much time you'd like to lock the IP address.

4) LOCK TIME FOR LOGIN FAILURES

Choose how much time you'd like to lock the IP address with several login attempts but failed (**1 MIN / 2 MINS / 3 MINS / 5 MINS / 10 MINS / 30 MINS / 1 HOUR**).

6.13 POWER CONTROL

Click to show the power off panel to halt, reboot or log out the system.

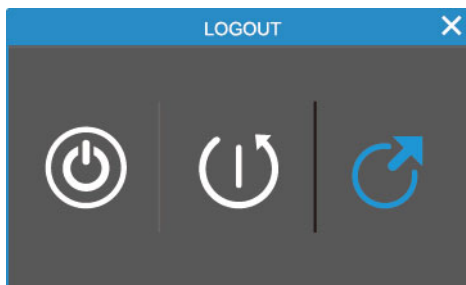

Icon	Meaning	Description
	System Halt	Click to stop the system and remove the power adapter.
	System Reboot	Click to reboot the system.
	System Logout	Click to log out the system and log in with another account.

6. REMOTE OPERATION

You can also control this recorder remotely via the web browser and iOS / Android devices.

6.2 Web Browser

You can view the images or operate your recorder with a web browser, for example, Microsoft Internet Explorer.

Note: The supported PC operation systems are Windows 10, Windows 8, Windows 7 and Windows Vista.

The user interface when you access via the web browser is nearly the same as the interface you see on the recorder, and the operations are also the same.

Note: The illustration below is just for your reference and may be different from what you actually see. Some functions and buttons are for selected models or certain user levels only.

Step 1: Key in the IP address used by this device in the URL address box, such as 60.121.46.236, and press Enter. You will be prompted to enter the user name and password to access the device.

If the port number this device used is NOT 80, you need to key in the port number additionally. The format is *ipaddress:portnum*.

For example, for the IP address 60.121.46.236 and port No. 888, please key in "http://60.121.46.236:888" into the URL address box, and press "Enter".

Step 2: Enter the user name and password, and click "OK". You will see a similar screen as the following when the login information is correct.

Note: The default user name and password for remote access are both "admin".

Current Streaming Information:
 FR: Frame rate
 DR: Data rate
 DATE TIME: Current system time

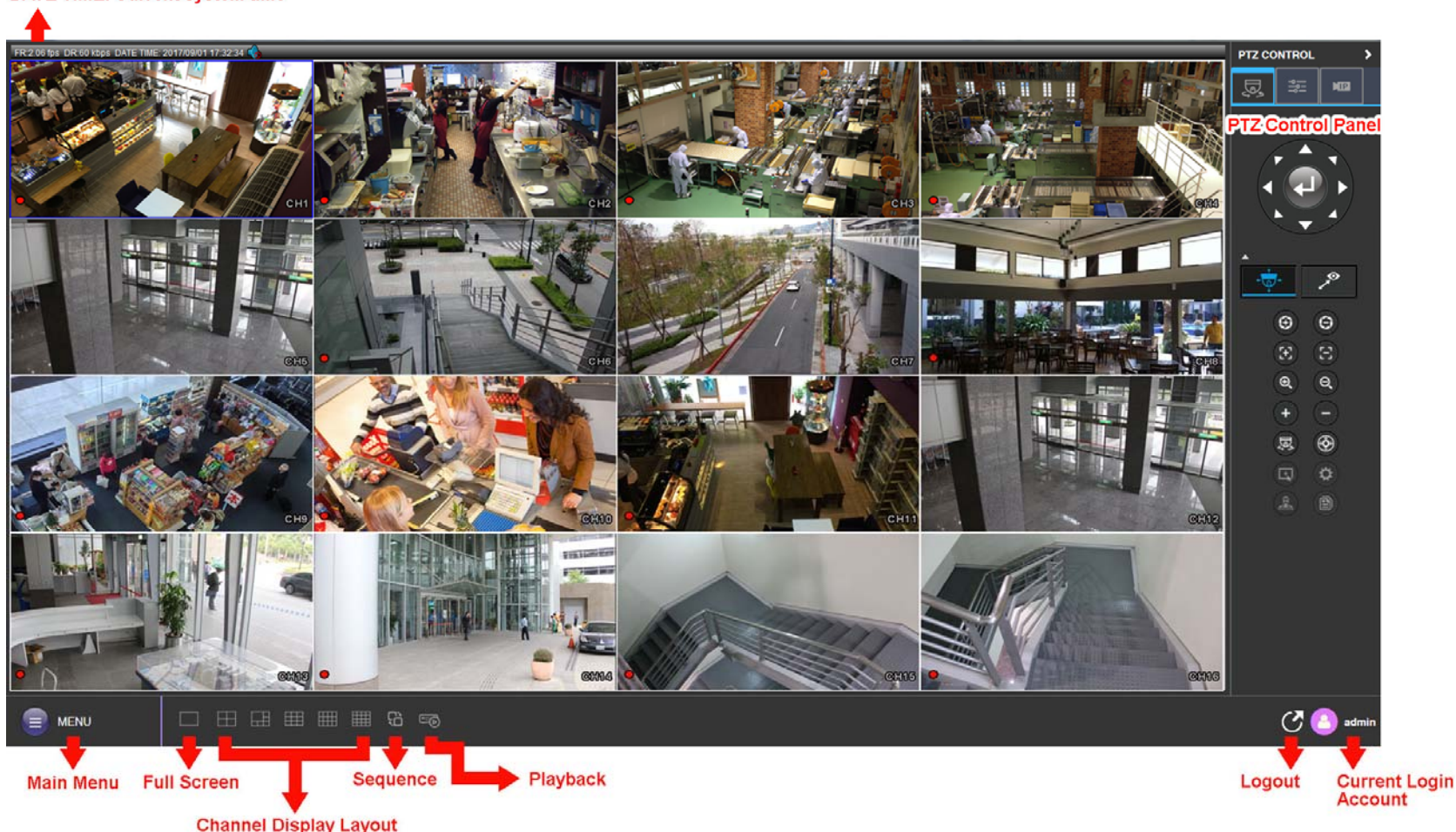

6.3 Mobile Devices

Note: For more details about mobile surveillance via your mobile device, please visit <http://info.eagleeyes.tw/iphone/index.html>.

EagleEyes is a mobile phone program used with our surveillance system for remote surveillance. It's compatible with iOS and Android mobile devices, and it's free (Except *EagleEyes Plus* for iOS OS, and *EagleEyes Plus+* for Android OS).

6.3.1 Prerequisites

Before installing *EagleEyes* to your mobile phone for remote surveillance, make sure you have checked the following:

- ✓ Your mobile platform is iOS or Android.
- ✓ Mobile Internet services are subscribed and available to use for your mobile device.

Note: You might be charged for Internet access via wireless or 4G networks. For the Internet access rate details, please check with your local network operator or service provider.

- ✓ You have noted down the IP address, port number, user name and password used to access your network camera from Internet.

6.3.2 Where to download

Go to **App Store / Play Store** from your iOS / Android mobile devices and search *EagleEyes* to download.

When the download is completed, *EagleEyes* will be installed automatically to the location where all applications are saved in your phone by default, or where you specify.

6.3.3 Setup

Step1: Open *EagleEyes* to go to the address book.

Step2: Then, click **Add** and select **Manual** to go to the setting page.

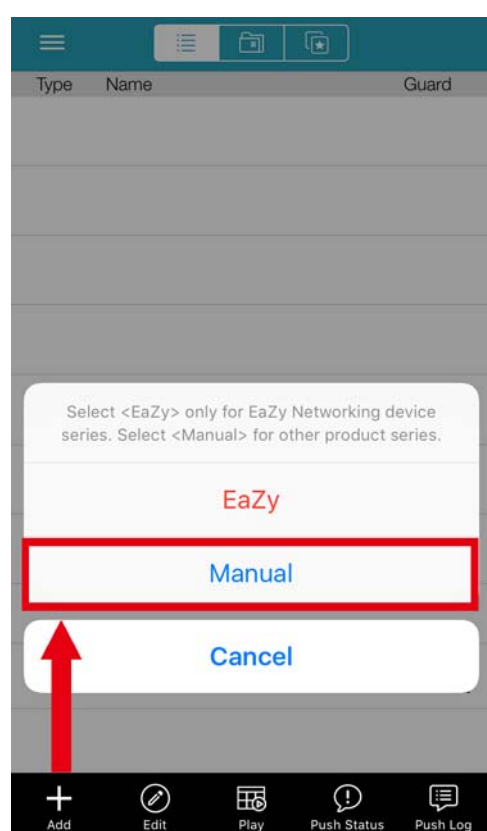

Step3: In the setting page, enter all the information needed to access this device in the **REQUIRED** column, and click **Get Type** to examine if the information you entered is correct. The device type will be detected properly.

Step4: (Optional) Configure the settings in the **OPTIONAL** column as needed.

The screenshot shows a configuration page with a teal header containing 'Cancel' and 'Save' buttons. Below the header, there are two sections: 'REQUIRED' and 'OPTIONAL'.
REQUIRED section:
 - Title: ezum demo
 - IP Address: avezum2.ddns.eagleeyes.1
 - Port: 8080
 - Username: ezum_demo
 - Password: ••••••••
 - A 'Get Type' button is shown with the detected device type 'DVR (16 CH)'.
OPTIONAL section:
 - Audio: A toggle switch is turned off, with 'CH1' and an info icon.
 - Quality of priority: A toggle switch is turned on.
 - Multiple Channel Resolution: Two buttons, 'Low' and 'High', with 'High' selected.
 - Single Channel Source: A dropdown menu set to 'Sub Stream' with an info icon.
 - Channel Title: A toggle switch is turned off.

Step5: Click **Save** to return to the address book. Enable **Guard** to receive Push Video.

The screenshot shows an address book interface with a teal header and a bottom navigation bar. The main area is a table with columns 'Type', 'Name', and 'Guard'.
 - The first row shows a device icon, the name 'ezum demo', and a 'Guard' toggle switch that is currently turned off. A red box highlights the toggle, and a red arrow points to it from below.
 - The bottom navigation bar contains five icons: 'Add', 'Edit', 'Play', 'Push Status', and 'Push Log'.

Step6: Click on the item you just added in the address book to access and check the live view.

APPENDIX 1 PRODUCT SPECIFICATIONS

		Model 1	Model 2
Hardware			
Video Input		One LAN port (up to 16 IP cameras)	
Video Output		HDMI x 2 / VGA x 1	HDMI x 2 / VGA x 1 / Composite x 1
Video Output Resolution		HDMI-1: Up to 3840 x 2160 (4K2K) HDMI-2 & VGA: Up to 1920 x 1080 (Full HD)	
Audio Output		YES (Line out / HDMI)	
Audio Input		YES (Mic in)	
Alarm I/O		4 in / 1 out	Alarm out only
HDD Storage**		Five 6TB hard disks	Eight 6TB hard disks
eSATA Port		YES	NO
RS485 Port		YES	NO
USB Ports		USB 3.0 x 1 / USB 2.0 x 2	
IR Remote Control		YES	
Ethernet	LAN port	1000Mbps	
	Internet (WAN) port	1000Mbps	
Software			
Video Compression Format		H.265	
Audio Compression Format		G.711	
Local / Remote Display Mode		16CH	
Local / Remote Playback Mode		16CH	
Single Channel Playback		YES	
Record Stream		Dual	
Recording Mode		Manual / Event / Alarm / Schedule	
Recording Throughput		Up to 480 IPS @ 2592 x 1944 (5MP), Up to 300Mbps	
Pre-alarm Recording		YES	
Quick Search		Time / Event	
Event Notification		Push Video / Push Status / Video Mail / Message Mail	
Security		Multiple user access levels with password	
Remote Access		(1) Internet Explorer on Windows operating system (2) EagleEyes on iOS & Android mobile devices (3) Our self-developed program, Video Viewer	
Max. Online User		20	
Multicast		YES	
Seamless Recording		YES	
Smart Search		YES	
Spot Monitor Setup		Call Monitor / Event Monitor / Live Monitor (HDMI-2 only)	
Alarm Scenario Setup		YES	
Alarm Pop-up & Preview		YES	

	Model 1	Model 2
General		
Power Source ($\pm 10\%$)	DC19V / 4.7A	DC19V / 3.42A
Operating Temperature	10°C ~ 40°C (50°F ~ 104°F)	
Operating Humidity	10% ~ 85%	
Dimensions (mm) ^{***}	432(W) × 90(H) × 326(D)	358(L) × 267(W) × 152(H)
Minimum PC Browsing Requirements	<ul style="list-style-type: none"> • Intel core i3 or higher, or equivalent AMD • 2GB RAM • AGP graphics card, Direct Draw, 32MB RAM • Windows 7, Windows Vista & Windows XP, DirectX 9.0 or later • Internet Explorer 7.x or later 	
Peripherals	Full HD Matrix (HDM02) Rack Mount (PP-AVC787-00K) PTZ Joystick (AVX102)	Full HD Matrix (HDM02) PTZ Joystick (AVX102)

* Specifications are subject to change without notice.

** Hard disks are optional

*** Dimensional tolerance: $\pm 5\text{mm}$

APPENDIX 2 PUSH VIDEO CONFIGURATION

A2.1 Alarm Sensor Connection

Connect the alarm sensor, such as magnetic contacts, to the alarm-in port on the rear panel. Alarm-in 1 corresponds to video channel 1, alarm-in 2 corresponds to video channel 2, and so on.

Note: The voltage restriction for alarm-in device connection is under DC24V 1A.

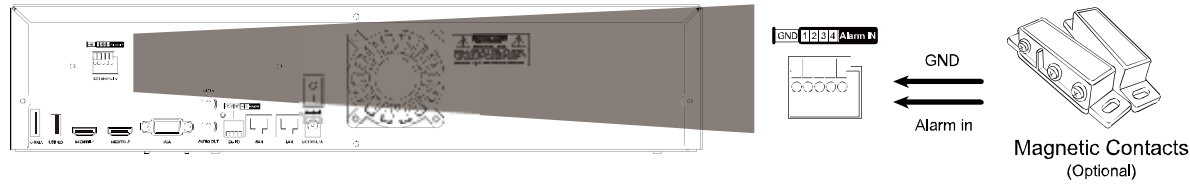

If the connected IP camera is our brand's IP camera with alarm I/O support, you can also connect the alarm sensor to the camera.

Note: Please check the user manual of the camera to know voltage restriction for alarm-in device connection.

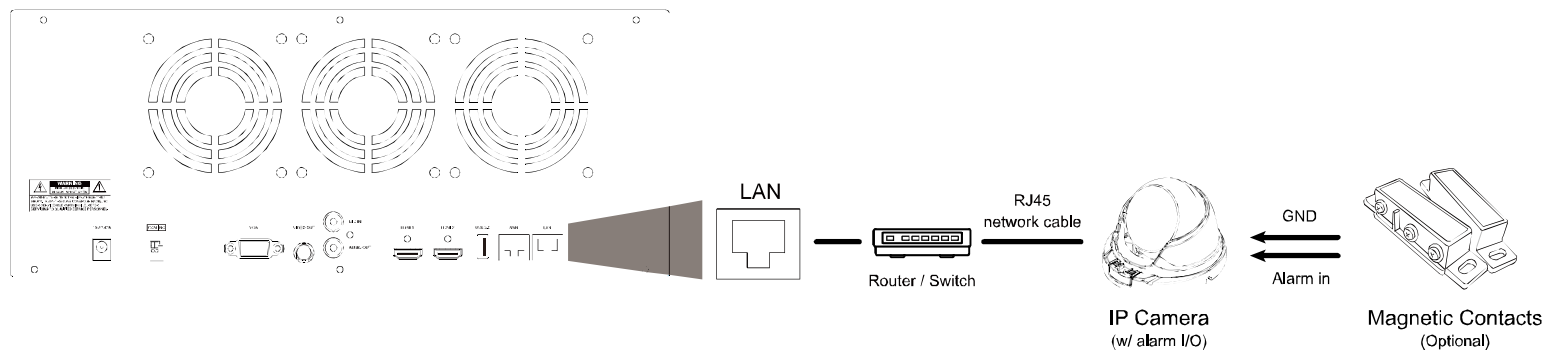

Then, go to **MENU → CAMERA → DETECTION** and make sure:

1. MOTION is set to **ON**.
2. **ALARM** is configured (**N.C.** / **N.O.**) when an external alarm device is connected, or **INTERNAL ALARM** is set to **ON** when the connected camera has a PIR sensor built-in.

DETECTION						
CHANNEL TITLE	ALARM	INTERNAL ALARM	SENSITIVITY	MOTION	AREA	ADVANCED CONFIG
CH1	OFF	ON		ON	EDIT	
CH2	N.C.	OFF		ON	EDIT	
CH3	N.O.	OFF		OFF	EDIT	
CH4	OFF	OFF		OFF	EDIT	
						APPLY

A2.2 Configuration

Before configuring Push Video, make sure:

1. The system is set up as described in “2. CONNECTION” at page 3.
2. This recorder is connected to Internet.
3. You’ve installed the app, EagleEyes, on your iOS or Android mobile devices.
For details, please refer to “6.3 Mobile Devices” at page54.

Step1: Go to **MENU** → **SCENARIO**, and enable the necessary rules:

If your alarm sensor is...	Please enable ...
External alarm sensor	1. PUSH VIDEO TRIGGERED BY EXTERNAL ALARM 2. MOTION DETECTION ON WHEN GUARD ON
PIR sensor built-in	1. PUSH VIDEO TRIGGERED BY BUILT-IN PIR SENSOR 2. MOTION DETECTION ON WHEN GUARD ON 3. INTERNAL ALARM (PIR) DETECTION ON WHEN GUARD ON

Step2: Open EagleEyes, and add this recorder to the EagleEyes address book.

A2.3 Enable Push Video

A2.3.1 From iOS Mobile Device (iPhone / iPad)

Step1: In the iPhone / iPad main menu, select **Settings** → **Notifications**. Select **EagleEyes**, and make sure the notification is set to on.

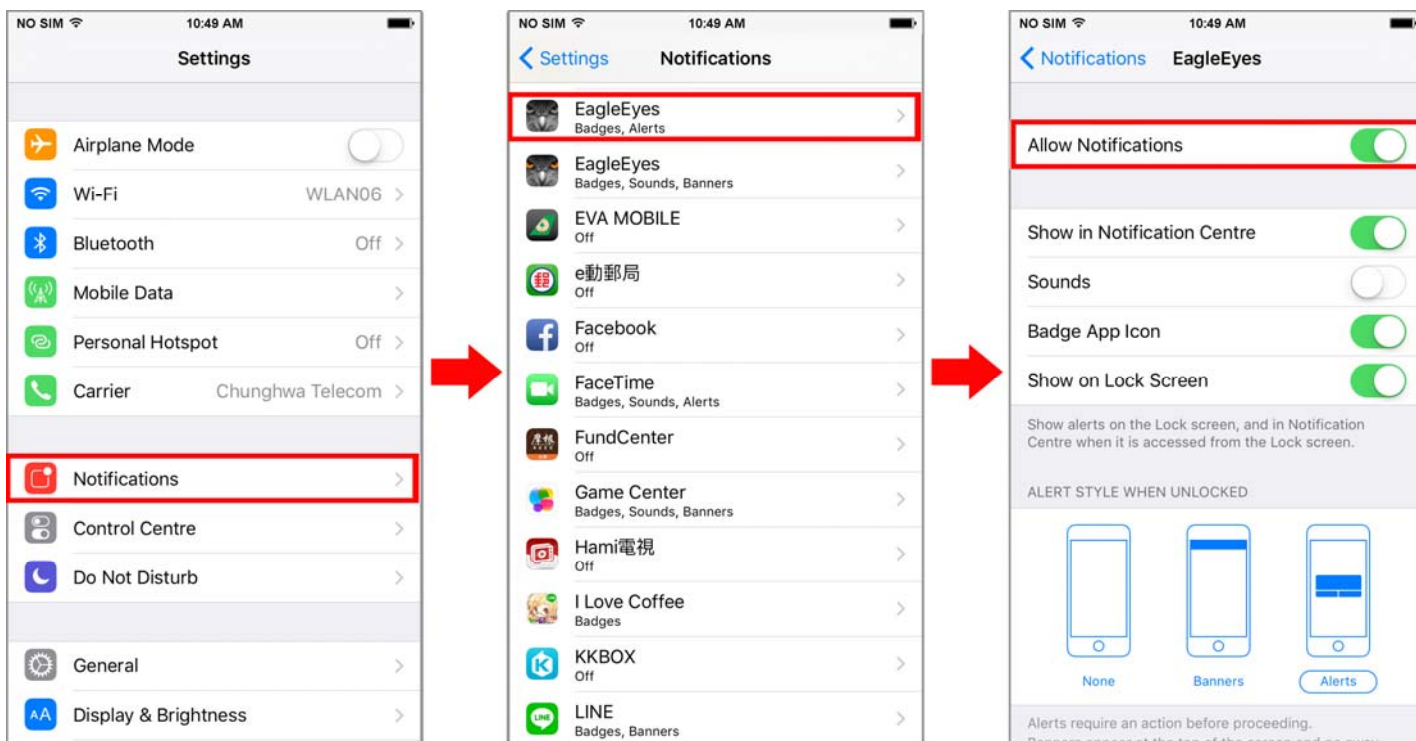

Step2: Open **EagleEyes**, and switch **Guard** to **ON**. You'll receive the message indicating that Push Video is on.

Step3: Return to the main page or standby page. You'll receive event notifications when there's an alarm event. Follow the on-screen instruction to immediately play the recorded clip.

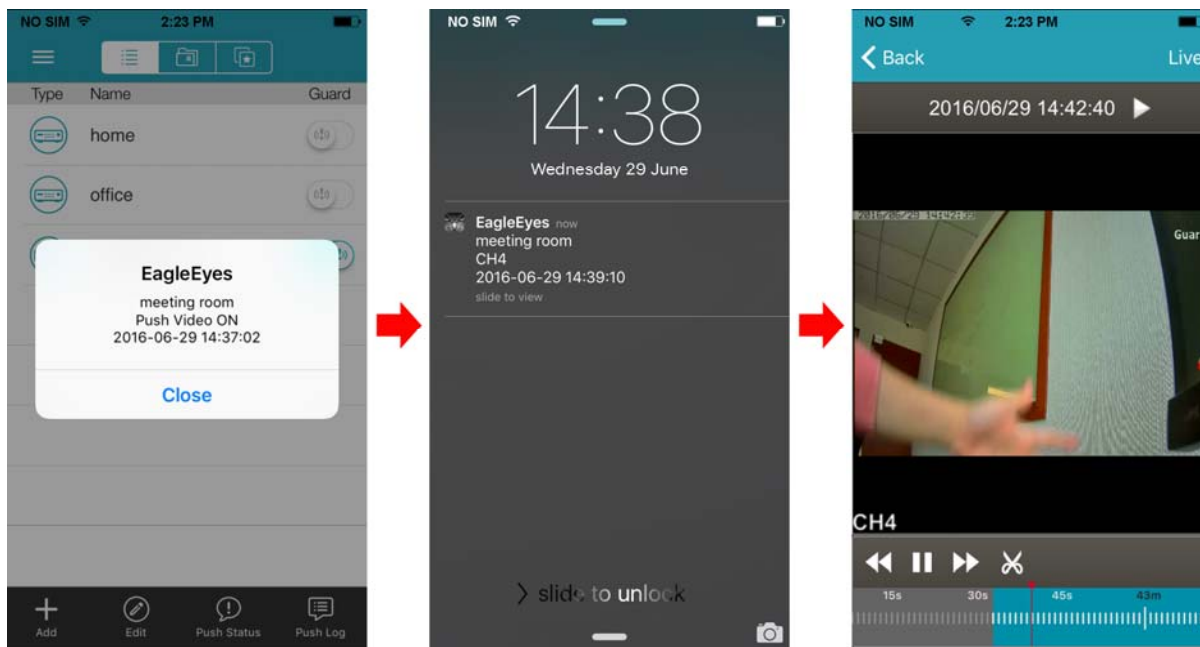

A2.3.2 From Android Mobile Device

Step2: Open **EagleEyes**, and switch **Guard** from **OFF** to **ON**. You'll receive the message indicating that Push Video is on.

Step3: Return to the main page or standby page. You'll receive event notifications when there's an alarm event. Follow the on-screen instruction to immediately play the recorded clip.

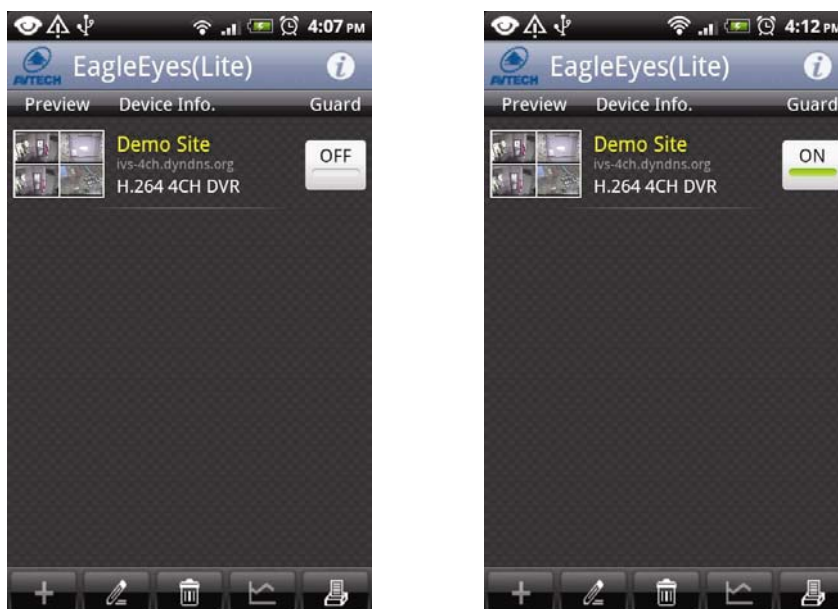

APPENDIX 3 COMPATIBLE USB FLASH DRIVE LIST

Please upgrade the firmware of the recorder to the latest version to ensure the accuracy of the following table. If the USB flash drive is not supported by the recorder, you will see  on the screen.

Note: Please use your PC to format the USB flash drive as "FAT32".

Note: You can backup up to 2GB video data for one-time USB backup. To backup more data, please set the time & channel(s) you want, and start USB backup again.

MANUFACTURER	MODEL	CAPACITY
Transcend	JFV35	4GB
	JFV30	8GB
Kingston	DataTraveler	1GB
PQI	U172P	4GB
Apacer	AH320	2GB
	AH320A	8GB
	AH220	1GB
	AH320	4GB
A-data	RB-18	1GB
Sandisk	Cruzer Micro	2GB
	Cruzer Micro	4GB
	Cruzer4-pk	2GB
Netac	U208	1GB
MSI	F200	4GB
SONY	Micro Vault Tiny 2GB	2GB
	Micro Vault Tiny 4GB	4GB
	Micro Vault Tiny	1GB

APPENDIX 4 COMPATIBLE HARD DISK LIST

Please upgrade the firmware of the device to the latest version to ensure the accuracy of the following table.

Note: It's necessary to install a hard disk first before firmware upgrade to ensure the upgrade process works properly.

Note: To use a green hard disk, use **ONLY** the hard disk designed especially for surveillance to ensure the device works properly.

Seagate*			
MODEL	CAPACITY	MODEL	CAPACITY
Pipeline HD ST3500312CSS	500GB	ST3000VX004	3TB
Pipeline HD ST500VT000	500GB	ST3000VX005	3TB
Pipeline HD ST1000VM002	1TB	ST3000VX006	3TB
Pipeline HD ST1000VM002	1TB	ST3000VX000	3TB
ST31000525SV	1TB	ST4000VM000	4TB
ST31000340AS	1TB	ST4000VX000	4TB
ST1000VX000	1TB	ST4000VX002	4TB
ST1000VX002	1TB	ST4000VX007	4TB
ST1000VX001	1TB	ST6000VX0001	6TB**
ST1000VX005	1TB	ST6000VX0011	6TB**
ST2000VX000	2TB	ST6000NM0024	6TB**
ST2000DM001	2TB	ST8000VX002	8TB**
ST2000VX004	2TB	ST8000VX0022	8TB**
ST3000VM002	3TB	ST100000VX0004	10TB**
WD			
MODEL	CAPACITY	MODEL	CAPACITY
WD10PURX	1TB	WD30EFRX	3TB
WD20PURX	2TB	WD40PURX	4TB
WD20EURS	2TB	WD40EURX	4TB
WD20EURX	2TB	WD60EURX	6TB**
WD20EFRX	2TB	WD60PURX	6TB**
WD2002FAEX	2TB	WD6001FFWX	6TB**
WD30PURX	3TB	WD6001FSYZ	6TB**
WD30EURX	3TB		
TOSHIBA			
MODEL	CAPACITY	MODEL	CAPACITY
DT01ACA050	500GB	MD03ACA200V	2TB
DT01ABA050V	500GB	DT01ABA300V	3TB
DT01ACA100	1TB	DT01ACA300	3TB
DT01ABA100V	1TB	MD03ACA300V	3TB
DT01ACA200	2TB	MD03ACA400V	4TB
DT01ABA200V	2TB	MD04ABA500V	5TB

* To know more details about SRS and its related support and service, please contact your local Seagate representative directly.

** Please be advised to pay attention to the heat dissipation of the hard disk which is over 4TB because it might generate much heat during operation. It's recommended that ambient temperature is not over 35°C.

APPENDIX 5 BATTERY REPLACEMENT

The time reset after power failure, for example, caused by a power outage, will cause the disorder of the recorded data, and users may have problems in searching the event clip they want. To keep the device time from resetting, a non-chargeable lithium battery, CR2032, is installed in the device.

However, the device time might still get reset when the battery is low or even running out of power. If so, please replace the device battery, CR2032, **right away** as instructed below.

➤ How to replace CR2032

Note: The lithium battery, CR2032, is a non-chargeable battery, and should be purchased separately. Please replace only with the same or equivalent type battery in case of danger.

Step1: Stop all recording **immediately** to prevent the disorder of the recorded data. Then, back up the recorded data if necessary.

Step2: Power off the device, and disconnect the power.

Step3: Remove the device upper cover or rear panel to find the battery on the mainboard.

Step4: Push the release as indicated below to remove the battery.



Type1

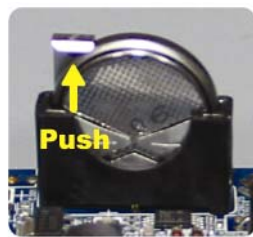

Type 2

Step5: Get a new battery and install it to its slot on the main board.

- For Type 1, install it with the side of “CR2032” facing up as shown above.
- For Type 2, install it without the side of “CR2032” facing you as shown above.

Step6: Replace the cover and connect to power.

Step7: Set the date & time, and resume recording.

APPENDIX 6 DISK ARRAY COMPATIBLE LIST

Here's the compatible list for disk arrays.

Note: For the compatible hard disks used for those disk arrays listed below, please check their respective user manuals or official websites.

Brand	Model Number
Proware	EP-D501-AA
	EP-2123-UA-R
RAIDON	GT1650-SB3
	GR3630-SB3
STARDOM	DR5-WBS3



APPENDIX 7 EAZY NETWORKING

EaZy Networking is a free P2P cloud service to connect AVTECH devices to the Internet automatically by plug-and-play, enabling you to check the live view via your mobile device or laptop at anytime.

In most cases, the device is connected via P2P. Connection via the relay server is only applied to some complex environments such as the private IP-based network environment used by a large enterprise. There is no speed limitation of P2P connection. For connection via the relay server, the speed is up to 10FPS@512kbps. To obtain stable transmission, it's recommended to purchase our data plan of 1GB or 7GB. Each device will enclose a 2GB data plan for a free trial.

EaZy Networking could be configured via EagleEyes on an iOS / android device, or via Internet Explorer.

Before using this function, make sure:

- This recorder is connected to a switch or router, and the switch or router is ready for Internet connection.
- The network icon on the bottom right corner is , not .
- You have an iOS / Android mobile device with EagleEyes installed.

A8.1 Via EagleEyes on iOS / Android Device

A8.1.1 Setup

Step1: Go to **MENU** → **NETWORK** → **WAN**. Set **NETWORK TYPE** to **DHCP**, and make sure the network icon on the bottom right corner is changed from  to .

Note: If the setting is made via the Setting Wizard, the network type will be automatically switched to DHCP.

WAN	WAN	
LAN	NETWORK TYPE	DHCP <input type="button" value="v"/>
DDNS	IP	192.168.1.112
E-MAIL	GATEWAY	192.168.1.254
FTP	NETMASK	255.255.255.0
MULTICASTING	PRIMARY DNS	168.95.1.1
EaZy	SECONDARY DNS	139.175.55.244
	PORT	88
	INTERNET AVAILABILITY ADDRESS	www.google.com
	MAC 00:0E:53:00:13:77	

Step2: In the same menu, select **EaZy**. Enable EaZy Networking, and leave this page open. You'll need to scan the QR code later.

WAN	EaZy	
LAN	ENABLE EAZY NETWORKING	ON
DDNS	 000E532B8613	
E-MAIL		
FTP		
MULTICASTING		
EaZy		

Step3: Open EagleEyes on your mobile device, and select “...” on the top left corner in the address book. Then, click “EaZy”.

Step4: Click “Login” and register an account for “Cloud Service”. If you’ve got an account, please just log in.

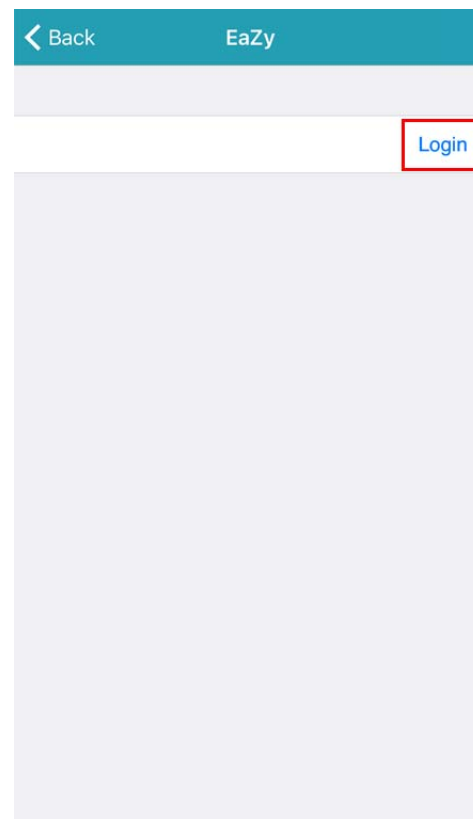
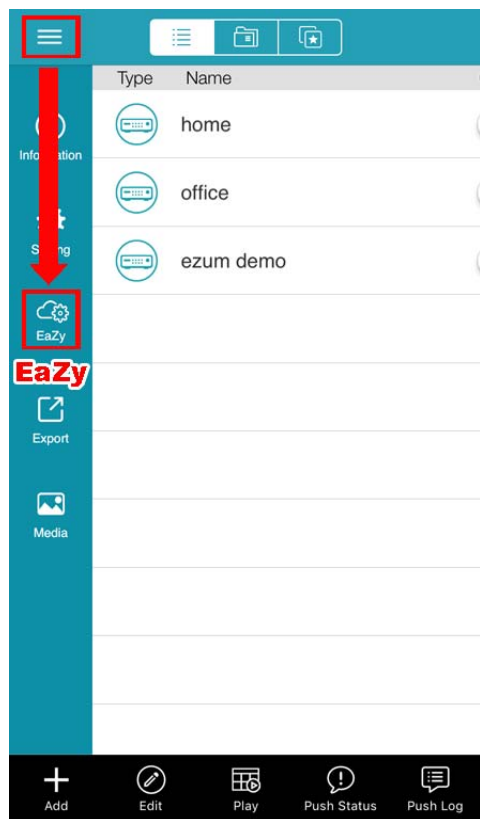

Step5: Go back to the address book and click “+” (Add) to add a new device. There are two methods to add new devices, “EaZy” and “Manual”. Select “EaZy”, and choose the recorder icon to continue.

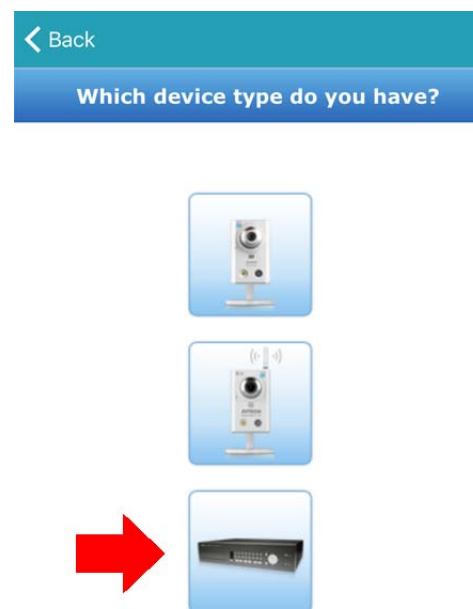
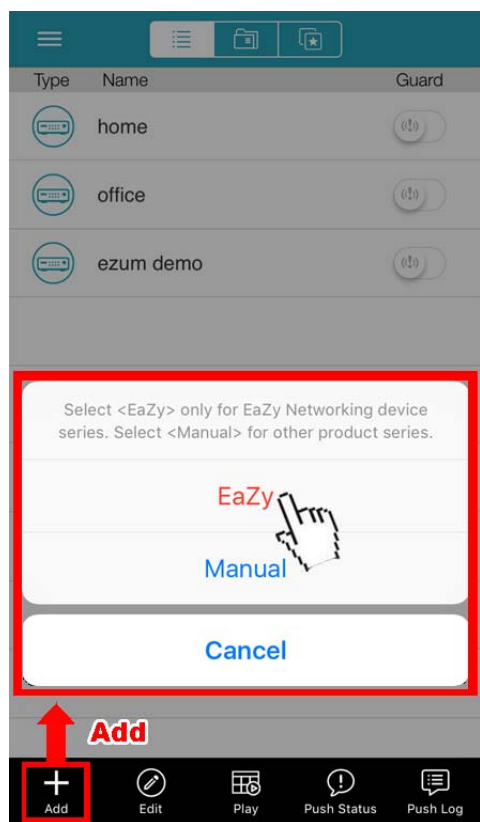

Step6: Click  in the section of "MAC address" to open the QR code scan page, and scan the QR code on the DVR screen mentioned in Step2. The MAC address will be filled automatically.

Fill in the Captcha code manually, and click "Apply".

Step7: Follow the on-screen instruction to finish the rest of the settings, and see if this device is added successfully to the address book as a cloud device.

At the same time, you'll be prompted to confirm if you want to remove the default user name and password.

- When the default user name and password are removed, you can **ONLY** use the user name and password of the cloud service to access this recorder locally and remotely. If you forget the user name and password of the cloud service, you could only reset the recorder and do all configurations again.
- When the default user name and password are kept, other people might be able to access this recorder if they know the default user name and password of this recorder.

Confirm if you want to keep the default account to continue, and return to the address book. You'll see the newly-added device in the address with a cloud icon on it.



Find the MAC address sticker on the rear panel or bottom of your device.

000E53E62B26

MAC address:
000E532...9 







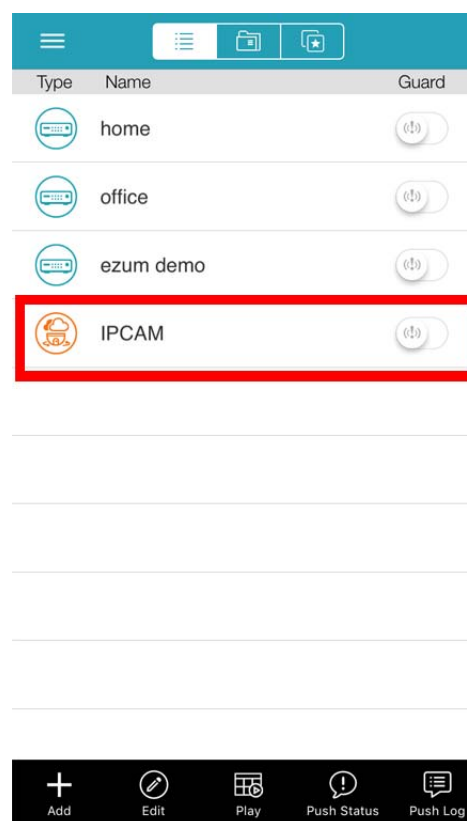

Ex.: "000E53E62B26"

Captcha: **Scan QR code**
88D76Y

8 8 D 7 6 Y

Back Apply



Type	Name	Guard
	home	
	office	
	ezum demo	
	IPCAM	

+

Add Edit Play Push Status Push Log

Step8: Click the newly-added device and see if you could access successfully.

A8.1.2 Checking Remaining Data Allowance

Step1: Log into the cloud service.

Step2: Select “Details” to go to account information, and select “Available Data Allowance”.

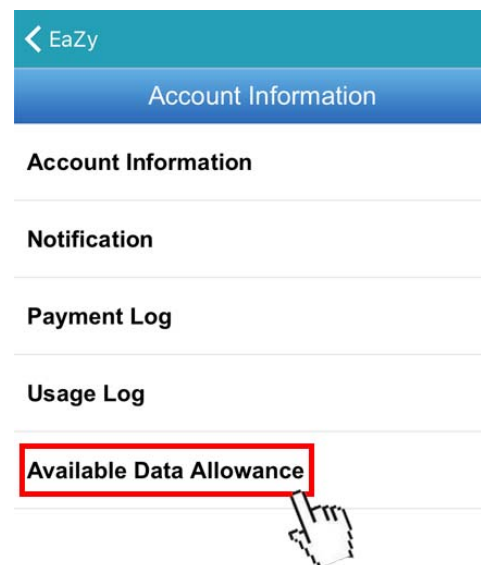
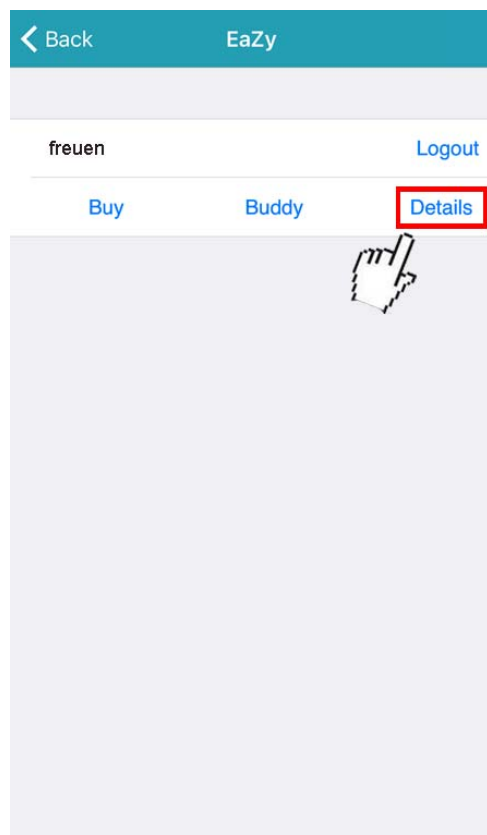

A8.1.3 Sharing Cloud Device Access with Other Account(s)

Note: One cloud device could be shared up to 30 cloud accounts, but the access to the device might be failed because it is still restricted to the maximum online user setup of the device.

Step1: Log into the cloud service.

Step2: Select “Buddy” to go to the buddy sharing page. Then, choose the device you want to share with, and switch from “OFF” to “Share”.

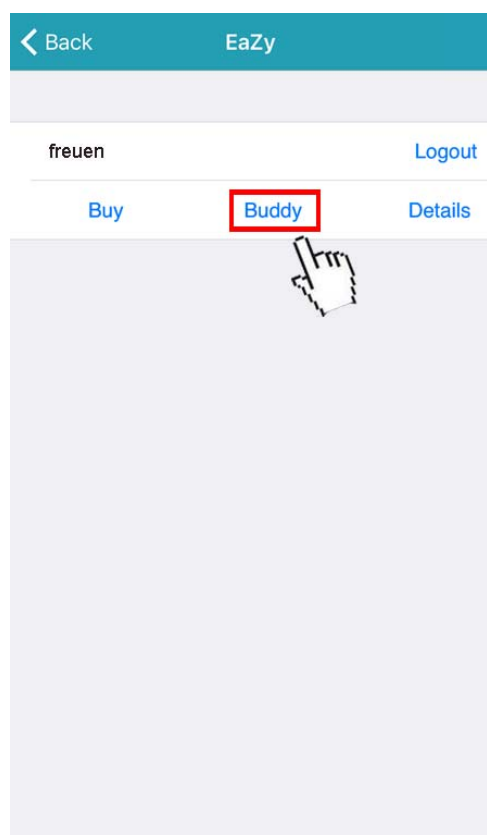

Step3: Choose the device you want to share with.

Step4: Enter the cloud account or the E-mail registered by the account, and select “Add”.

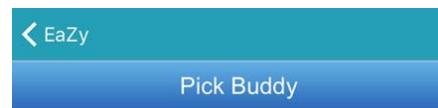
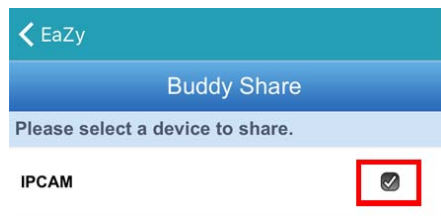

Please enter a buddy's account or Email, or you could pick one from 'Buddy List' alternatively.



Step4: Check again the account with which you want to share your cloud device, and select “Next” to confirm and continue.

Step5: Specify the access permission of the specified account, which account’s data allowance should be consumed after access successfully, and how long the account is allowed to stay after access successfully.

➤ Who should pay data allowance:

Who should pay data allowance	The order to consume data allowance
I	The free data allowance provided by the device -> The additional data allowance shared to other account(s) by the owner -> The additional data allowance of the device’s owner -> The data allowance shared to other account(s) by the buddy
Buddy	The additional data allowance of the buddy -> The data allowance shared with other account(s) by the buddy

Note: When there’s no data allowance to use, the network transmission will be down to 1 FPS. To restore the fluency of live view, users need to subscribe a data plan from EagleEyes, or configure the network settings by themselves.

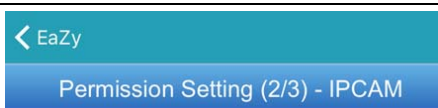
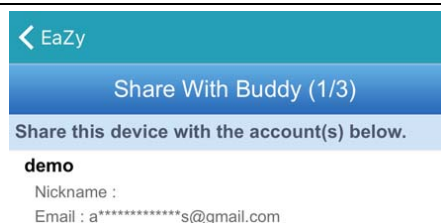

Who pay for data allowance: Buddy

Connection time limit: 1 Minute

User level: NORMAL

SUPERVISOR :
Can configure and customize all settings, hear audio stream, and receive Push Video / Push Status notifications.

POWER USER :
Can do remote playback.

NORMAL :
Can perform basic control.

GUEST :
Can only see live stream.



Step6: Check again the configurations you made for the account to which you want to share your cloud device, and select "Share!" to confirm.

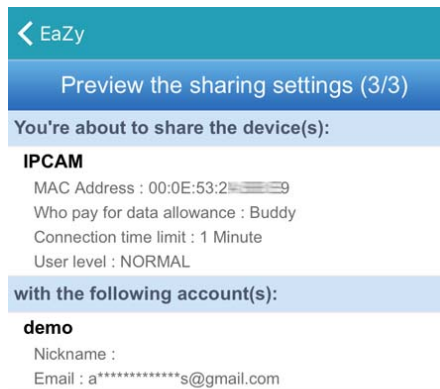

Step7: (Optional) Configure the data allowance shared to other accounts to use.

Step8: Return to the address book of EagleEyes. You'll see the device being shared is marked with an icon of two people.

A8.2 Via Internet Explorer on PC / Laptop

Note: EaZy Networking setup via a web browser is only available on Internet Explorer.

A8.2.1 Setup

Step1: Go to **MENU** → **NETWORK** → **WAN**. Set **NETWORK TYPE** to **DHCP**, and make sure the network icon on the bottom right corner is changed from  to .

Note: If the setting is made via the Setting Wizard, the network type will be automatically switched to DHCP.

WAN	WAN	
LAN	NETWORK TYPE	DHCP <input type="button" value="v"/>
DDNS	IP	192.168.1.112
E-MAIL	GATEWAY	192.168.1.254
FTP	NETMASK	255.255.255.0
MULTICASTING	PRIMARY DNS	168.95.1.1
EaZy	SECONDARY DNS	139.175.55.244
	PORT	88
	INTERNET AVAILABILITY ADDRESS	www.google.com
	MAC 00:0E:53:00:13:77	

Step2: In the same menu, select **EaZy**. Enable EaZy Networking, and leave this page open. You'll need to scan the QR code later.

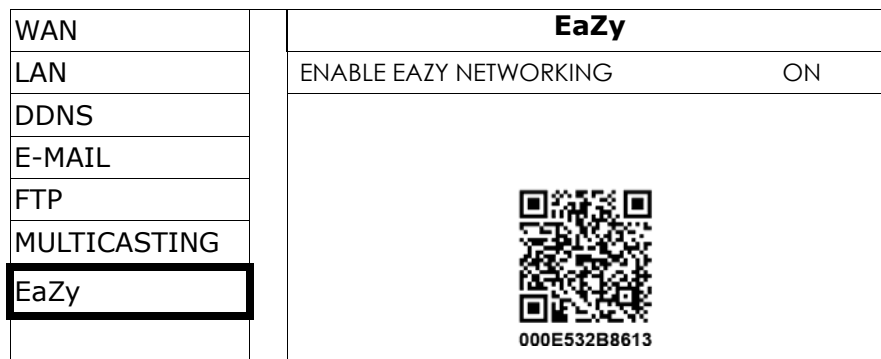

Step3: Open Internet Explorer on a PC / laptop, and enter <https://ez.eagleeyes.tw>.

In the login page, register an account for "Cloud Service". If you've got an account, please just log in.

Note: You PC must be connected to Internet.

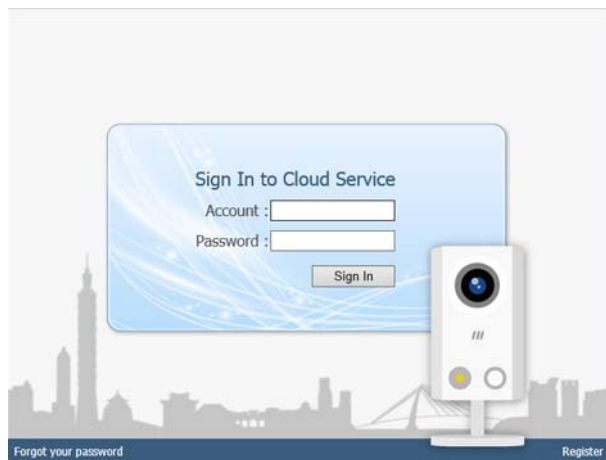

Step4: Click + on the left pane, and you'll be prompted to install plugins: **EaZy Control** and **EaZy Wizard**. Please follow the instructions to install these two plugins to ensure the service works properly.

Note: If you're not prompted to install the plugin, please lower the security level of Internet Explorer, and try to log into the cloud service again.



Step5: Enable EaZy Wizard, and click “Start” to go to the login page. Log into the cloud service.



Step6: Select the recorder picture, or choose “DVR / NVR” on the bottom right corner. Then, enter the MAC address you wrote down in Step2, and the security code.

Click “Apply” to continue.

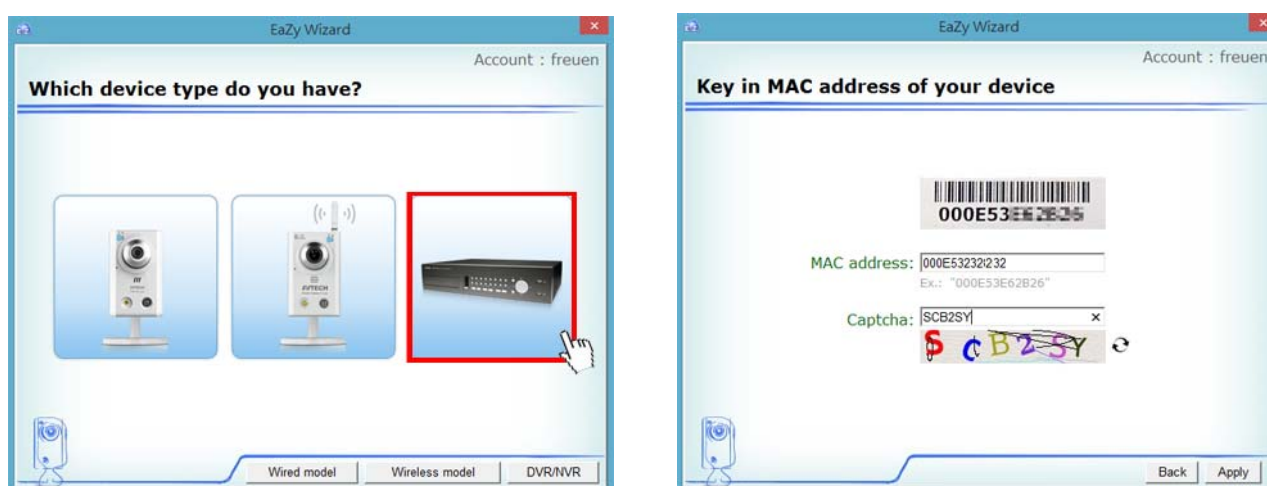

Step7: When your device is found, you’ll be directed to the next page to change the device title if you want.

Note: The device name changed here will be fixed and can’t be changed later.

Click “Apply” to continue. You’ll be prompted to confirm if you want to remove the default user name and password.

- When the default user name and password are removed, you can **ONLY** use the user name and password of the cloud service to access this recorder locally and remotely. If you forget the user name and password of the cloud service, you could only reset the recorder and do all configurations again.
- When the default user name and password are kept, other people might be able to access this recorder if they know the default user name and password of this recorder.

Confirm if you want to keep the default account, and click “Apply” to continue and return to the main page.

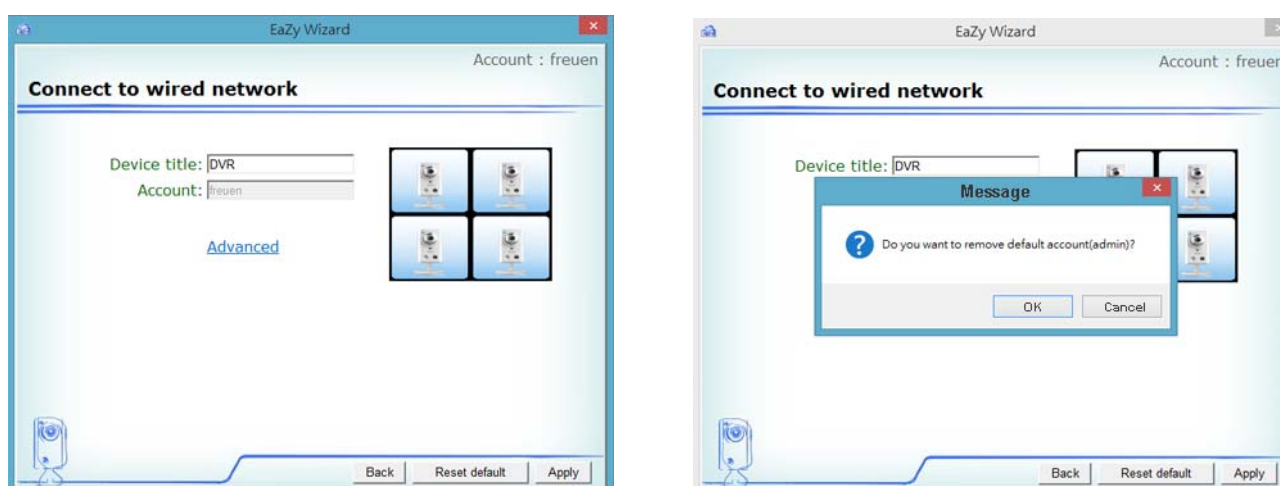

Step8: You'll see the newly-added device with a cloud icon on the left pane. Drag and hold the device to the display area on the right pane to show in the same window, or simply double-click the device to open the device view in another window.



A8.2.2 Checking Remaining Data Allowance

Step1: Log into the cloud service.

Step2: Select “Account Information” on the top right corner to go to account information, and select “Available Data Allowance”.

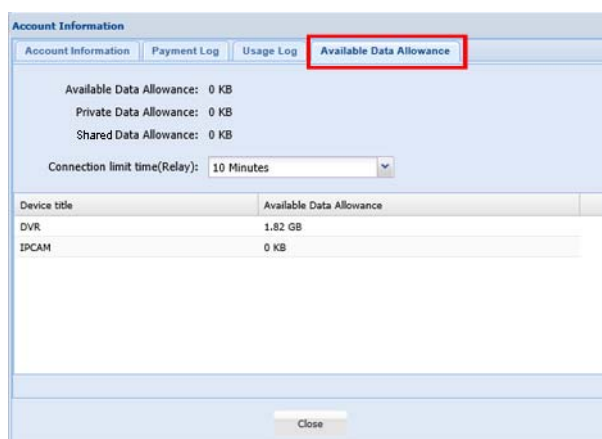

A8.2.3 Sharing Cloud Device Access to Other Account(s)

Note: One cloud device could be shared up to 30 cloud accounts, but the access to the device might be failed because it is still restricted to the maximum online user setup of the device.

Step1: Log into the cloud service.

Step2: Select “Buddy Share” to go to the buddy sharing page. Then, choose the tag “Your own device(s)”, and select “Share With Buddy”.

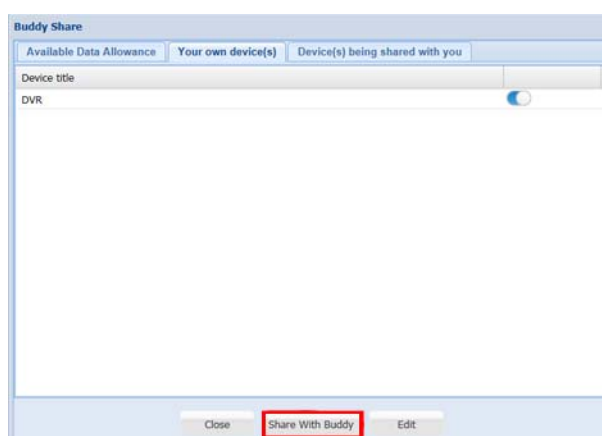

Step3: Choose the cloud device you want to share, and click “Next” to enter the cloud account or the E-mail registered by the account you want to share with. Then, select “Add”.

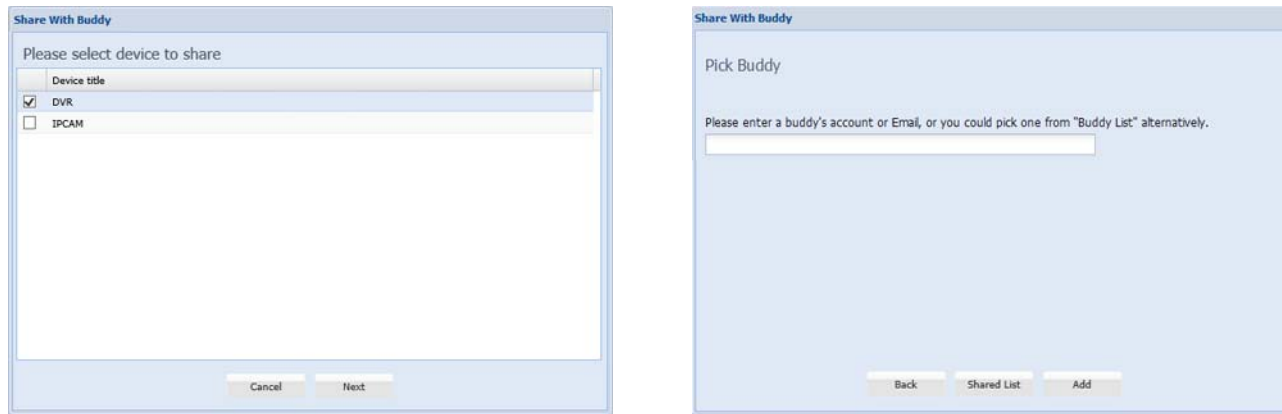

Step4: Check again the account to which you want to share your cloud device.

To add more accounts, select “Add”; to remove the existing account, select “Delete”; to continue buddy setup, select “Next”.

Step5: Specify the access permission of the specified account, which account’s data allowance should be consumed after access successfully, and how long the account is allowed to stay after access successfully.

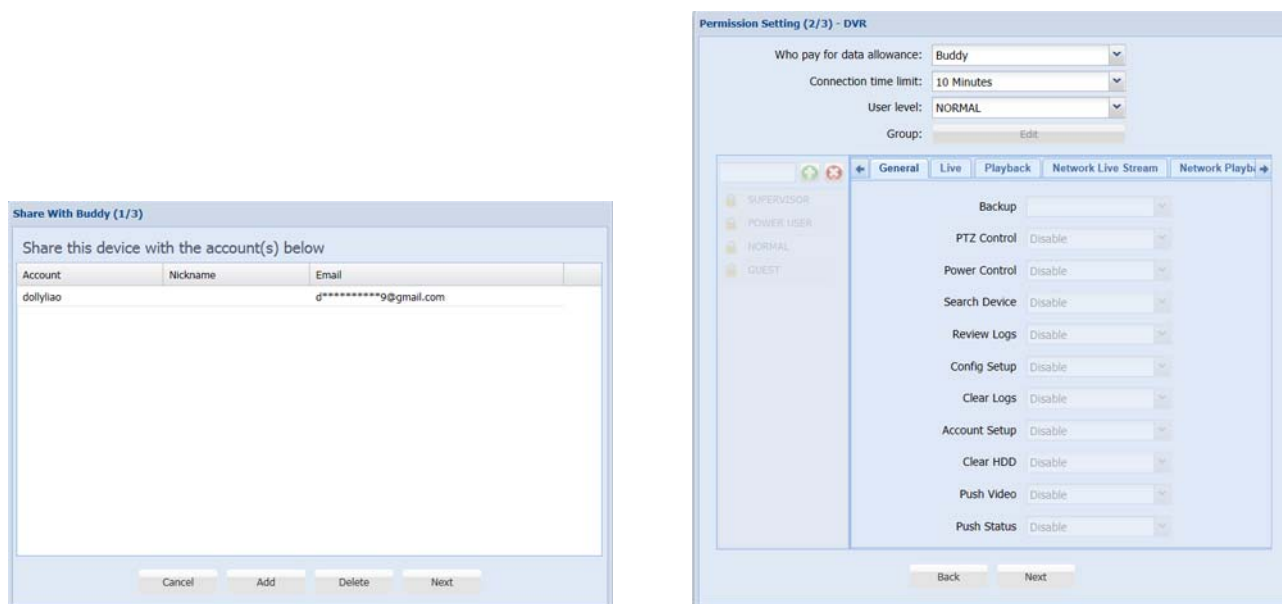

➤ Who should pay data allowance:

Who should pay data allowance	The order to consume data allowance
I	The free data allowance provided by the device -> The additional data allowance shared to other account(s) by the owner -> The additional data allowance of the device’s owner -> The data allowance shared to other account(s) by the buddy
Buddy	The additional data allowance of the buddy -> The data allowance shared with other account(s) by the buddy

Note: When there’s no data allowance to use, the network transmission will be down to 1 FPS. To restore the fluency of live view, users need to subscribe a data plan from EagleEyes, or configure the network settings by themselves.







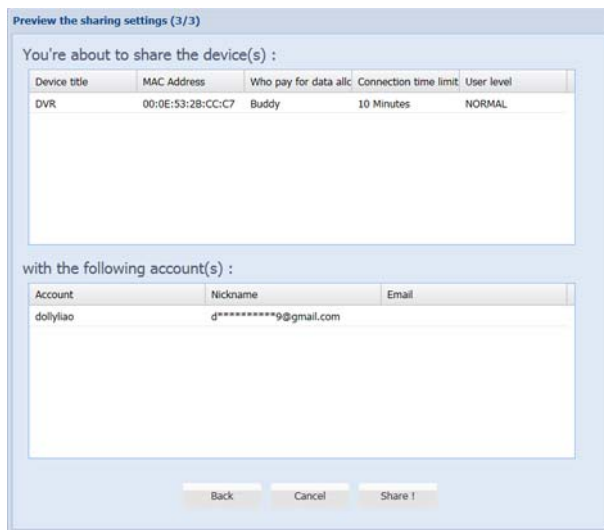

Step6: Check again the configurations you made for the account to which you want to share your cloud device, and select “Share!” to continue.

Step7: (Optional) Configure the data allowance shared to other accounts to use.

Step8: Return to the main page. You'll see the device being shared is marked with an icon of two people.



A8.3 Icons

Icon	Color	Indication
	Teal	This device is a DVR or NVR.
	Blue	This device is a DVR or NVR.
	Orange	This device is an IP speed dome camera.
	Red	This device is disconnected and unidentified.
 or 	Depending on the device color	This device is configured to the Internet via EaZy Networking (AVTECH Cloud Service). The cloud icon will be grayed out if the EaZy server can't be connected.
	Depending on the device color	You've shared the access right of the device with other cloud account via Buddy (AVTECH Cloud Service). The icon will be grayed out if you disable the device share.
	Depending on the device color	The icon will be grayed out if the device share is disabled by the owner of the device.

For example, if you see  as the device type, you'll know:

- This device is an IP camera.
- This device is connected to the Internet via EaZy Networking.
- You were shared with the access right of the device, but the device share is disabled now.